



Radio Measurement and Test Report For

**Dongguan Mingke Acoustics Technology Co.,Ltd.
True wireless stereo earphone**

Applicant : Dongguan Mingke Acoustics Technology Co.,Ltd.
Address : 7/F Building A, No.2 Lilian Rd, Tangxia Town,
DongGuan City, China
Product Name : True wireless stereo earphone
Brand Name : N/A
Model No : MK-56, MK013, MK-016, MK-015, MK017, MK009S,
MK029Plus, MK020, MK011, MK031, MK032,
MK033, MK035, MK036, MK037, M-01, M-02, M-03,
M-05, M-06, M-07, MK56, MK011, MK013,
MK013C-2.4G, MK015, MK016, MK017, MK009S,
MK029, MK029 Plus, MK020, MK031, MK032,
MK033, MK035, MK036, MK037, MK038, MK039,
M-01, M-02, M-03, M-05, M-06, M-07
Standards : ETSI EN 300 328 V2.2.2
Report No : MTL24052422201E03
Date of Receipt sample : 2024-05-24
Date of Test : 2024-05-24 to 2024-05-27
Date of Issue : 2024-05-27
Test Result : PASS

Remarks:

The results shown in this test report refer only to the sample(s) tested, this test report cannot be reproduced, except in full, without prior written permission of the company. The report would be invalid without specific stamp of test institute and the signatures of compiler and approver.

Prepared By:

Shenzhen MTL Testing Technology Co., Ltd.

6th Floor, Building 4, No. 22, Dawangshan Second Industrial Zone, Shajing, Baoan District,
Shenzhen City, Guangdong Province, China.

Tel: +86-0755-23143231 Fax: +86-0755-23143231



TABLE OF CONTENTS

1. GENERAL INFORMATION 4

1.1 PRODUCT DESCRIPTION FOR EQUIPMENT UNDER TEST (EUT) 4

1.2 TEST STANDARDS 5

1.3 TEST METHODOLOGY 5

1.4 EUT SETUP AND TEST MODE 5

1.5 MEASUREMENT UNCERTAINTY 6

1.6 TEST EQUIPMENT LIST AND DETAILS 7

2. SUMMARY OF TEST RESULTS 8

3. RF OUTPUT POWER 9

3.1 STANDARD APPLICABLE 9

3.2 TEST PROCEDURE 9

3.3 SUMMARY OF TEST RESULTS 10

4. ACCUMULATED TRANSMIT TIME, FREQUENCY OCCUPATION AND HOPPING SEQUENCE 12

4.1 STANDARD APPLICATION 12

4.2 TEST PROCEDURE 12

4.3 SUMMARY OF TEST RESULTS/PLOTS 14

5. HOPPING FREQUENCY SEPARATION 15

5.1 STANDARD APPLICATION 15

5.2 TEST PROCEDURE 15

5.3 SUMMARY OF TEST RESULTS/PLOTS 16

6. OCCUPIED CHANNEL BANDWIDTH 17

6.1 STANDARD APPLICATION 17

6.2 TEST PROCEDURE 17

6.3 SUMMARY OF TEST RESULTS/PLOTS 18

7. TRANSMITTER UNWANTED EMISSIONS IN THE OUT-OF-BAND DOMAIN 22

7.1 STANDARD APPLICATION 22

7.2 TEST PROCEDURE 22

7.3 SUMMARY OF TEST RESULTS/PLOTS 24

8. TRANSMITTER UNWANTED EMISSIONS IN THE SPURIOUS DOMAIN 28

8.1 STANDARD APPLICABLE 28

8.2 TEST PROCEDURE 28

8.3 SUMMARY OF TEST RESULTS/PLOTS 28

9. RECEIVER SPURIOUS EMISSIONS 35

9.1 STANDARD APPLICABLE 35

9.2 TEST PROCEDURE 35

9.3 SUMMARY OF TEST RESULTS/PLOTS 35

10. RECEIVER BLOCKING 40

10.1 STANDARD APPLICATION 40

10.2 TEST PROCEDURE 42

10.3 TEST SETUP 43

10.4 SUMMARY OF TEST RESULTS/PLOTS 44



Report version

Version No.	Date of issue	Description
Rev.00	/	/
/	/	/



1. GENERAL INFORMATION

1.1 Product Description for Equipment Under Test (EUT)

TEST REPORT DECLARATION

Applicant : Dongguan Mingke Acoustics Technology Co., Ltd.

Manufacturer : Dongguan Mingke Acoustics Technology Co., Ltd.

EUT Description : True wireless stereo earphone

- (A) Model No. : MK-56
MK013, MK-016, MK-015, MK017, MK009S, MK029Plus, MK020,
MK011, MK031, MK032, MK033, MK035, MK036, MK037, M-01,
M-02, M-03, M-05, M-06, M-07, MK56, MK011, MK013, MK013C-2.4G,
- (B) Serial No. : MK015, MK016, MK017, MK009S, MK029, MK029 Plus, MK020,
MK031, MK032, MK033, MK035, MK036, MK037, MK038, MK039,
M-01, M-02, M-03, M-05, M-06, M-07
- (C) Power Supply : 5V $\overline{\text{---}}$

Test Procedure Used:
ETSI EN 300 328 V2.2.2

The devices described above have been tested by **Shenzhen MTL Testing Technology Co., Ltd** to determine the maximum emission levels emanating from the device, the severe levels that the device can endure and EUT'S performance criterion. The test results are contained in this test report. **Shenzhen MTL Testing Technology Co., Ltd.** is assumed of full responsibility for the accuracy and completeness of these tests.

This report applies to above tested sample only and shall not be reproduced in part without written approval of **Shenzhen MTL Testing Technology Co., Ltd.**

Prepared by:

Kaka fan

Project Engineer

Reviewed by:

Zhan Cai

Project Manager

Approved by:

Rouyeh

Technical Director



1.2 Test Standards

The tests were performed according to following standards:

ETSI EN 300 328 V2.2.2 Electromagnetic compatibility and Radio spectrum Matters (ERM); Wideband transmission systems; Data transmission equipment operating in the 2,4 GHz ISM band and using wide band modulation techniques; Harmonized EN covering essential requirements under article 3.2 of the RED Directive.

Maintenance of compliance is the responsibility of the manufacturer. Any modification of the product maybe which result in lowering the emission/immunity should be checked to ensure compliance has been maintained

1.3 Test Methodology

All measurements contained in this report were conducted with ETSI EN 300328, The equipment under test (EUT) was configured to measure its highest possible emission level. For more detail refer to the Operating Instructions.

1.4 EUT Setup and Test Mode

The equipment under test (EUT) was configured to measure its highest possible emission/immunity level. The test modes were adapted according to the operation manual for use, the EUT was operated in the engineering mode to fix the Tx/Rx frequency that was for the purpose of the measurements, more detailed description as follows:

Test Mode List		
Test Mode	Description	Remark
TM1	True wireless stereo earphone	MK-56

Modulation Configure			
Modulation	Packet	Packet Type	Packet Size
GFSK	DH1	4	27
	DH3	11	183
	DH5	15	339
Pi/4 DQPSK	2DH1	20	54
	2DH3	26	367
	2DH5	30	379
8DPSK	3DH1	24	83
	3DH3	27	552
	3DH5	31	1021

Note: The bluetooth has been tested on the modulation of GFSK, (Pi/4)DQPSK and 8DPSK, compliance test and record the worst case.



	NTNV	LTNV	HTNV
Temperature (°C)	20	-10	40
Voltage (V)	5.0		
Relative Humidity:			45 %.
ATM Pressure:			1019 mbar

EUT Cable List and Details			
Cable Description	Length (m)	Shielded/Unshielded	With / Without Ferrite
/	/	/	/

Special Cable List and Details			
Cable Description	Length (m)	Shielded/Unshielded	With / Without Ferrite
/	/	/	/

Auxiliary Equipment List and Details			
Description	Manufacturer	Model	Serial Number
Adapter	Dell Inc.		/
AUX Line	PHILIPS		/
USB CABLE	UGREEN		/
iPhone6 Plus	Apple		

1.5 Measurement Uncertainty

Measurement uncertainty		
Parameter	Uncertainty	Note
Conducted RF Output Power	$\pm 0.42\text{dB}$	(1)
Occupied Bandwidth	$\pm 1 \times 10^{-7}$	(1)
Conducted Power Spectral Density	$\pm 0.70\text{dB}$	(1)
Radiated Spurious Emissions	30-200MHz $\pm 4.52\text{dB}$	(1)
	0.2-1GHz $\pm 5.56\text{dB}$	(1)
	1-6GHz $\pm 3.84\text{dB}$	(1)
	6-18GHz $\pm 3.92\text{dB}$	(1)

(1) This uncertainty represents an expanded uncertainty expressed at approximately the 95% confidence level using a coverage factor of $k=1.96$.

**1.6 Test Equipment List and Details**

Description	Manufacturer	Model	Serial Number	Cal Date	Due Date
Spectrum Analyzer	Agilent	N9020A	US47140102	2024-05-27	2025-05-26
Signal Generator	Agilent	83752A	3610A01453	2024-05-27	2025-05-26
Vector Signal Generator	Agilent	N5182A	MY47070202	2024-05-27	2025-05-26
Power Sensor	Agilent	U2021XA	MY54250019	2024-05-27	2025-05-26
Power Sensor	Agilent	U2021XA	MY54250021	2024-05-27	2025-05-26
Simultaneous Sampling	Agilent	U2531A	TW54243509	2024-05-27	2025-05-26
Spectrum Analyzer	Agilent	E4407B	MY41440400	2024-05-27	2025-05-26
Spectrum Analyzer	Rohde & Schwarz	FSP30	836079/035	2024-05-27	2025-05-26
EMI Test Receiver	Rohde & Schwarz	ESVB	825471/005	2024-05-27	2025-05-26
Amplifier	Agilent	8447F	3113A06717	2024-05-27	2025-05-26
Amplifier	C&D	PAP-1G18	2002	2024-05-27	2025-05-26
Trilog Broadband Antenna	SCHWARZBECK	VULB9163	9163-333	2024-05-27	2025-05-26
Horn Antenna	ETS	3117	00086197	2024-05-27	2025-05-26
Temperature&Humidity Chamber	GONGWEN	GDJS-800	/	2024-05-27	2025-05-26
DC Power Supply	ATTEN	APS3005Dm	/	2024-05-27	2025-05-26
Universal Radio Communication Tester	Rohde & Schwarz	CMW500	/	2024-05-27	2025-05-26

Software List			
Description	Manufacturer	Model	Version
EMI Test Software (Radiated Emission)*	Farad	EZ-EMC	RA-03A1
EMI Test Software (Conducted Emission)*	Farad	EZ-EMC	RA-03A1

*Remark: indicates software version used in the compliance certification testing



2. SUMMARY OF TEST RESULTS

Standards	Reference	Description of Test Item	Result
EN 300 328	4.3.1.2 / 4.3.2.2	RF Output Power	Passed
	4.3.2.3	Power Spectral Density	N/A
	4.3.1.3 / 4.3.2.4	Duty Cycle, Tx-sequence, Tx-gap	N/A
	4.3.1.4	Accumulated Transmit Time, Frequency Occupation and Hopping Sequence	Passed
	4.3.1.5	Hopping Frequency Separation	Passed
	4.3.1.6 / 4.3.2.5	Medium Utilisation (MU) Factor	N/A
	4.3.1.7 / 4.3.2.6	Adaptivity (Adaptive Frequency Hopping)	N/A
	4.3.1.8 / 4.3.2.7	Occupied Channel Bandwidth	Passed
	4.3.1.9 / 4.3.2.8	Transmitter Unwanted Emissions in the Out-of-band Domain	Passed
	4.3.1.10 / 4.3.2.9	Transmitter Unwanted Emissions in the Spurious Domain	Passed
	4.3.1.11 / 4.3.2.10	Receiver Spurious Emissions	Passed
	4.3.1.12 / 4.3.2.11	Receiver Blocking	Passed
	4.3.1.13 / 4.3.2.12	Geo-location capability	N/A

Passed: The EUT complies with the essential requirements in the standard
Failed: The EUT does not comply with the essential requirements in the standard
N/A: not applicable



3. RF Output Power

3.1 Standard Applicable

According to Section 4.3.1.2.3, the maximum RF output power for adaptive Frequency Hopping equipment shall be equal to or less than 20 dBm. The maximum RF output power for non-adaptive Frequency Hopping equipment, shall be declared by the supplier. The maximum RF output power for this equipment shall be equal to or less than the value declared by the supplier. This declared value shall be equal to or less than 20 dBm.

According to Section 4.3.2.2.3, for adaptive equipment using wide band modulations other than FHSS, the maximum RF output power shall be 20 dBm. The maximum RF output power for non-adaptive equipment shall be declared by the supplier and shall not exceed 20 dBm. For non-adaptive equipment using wide band modulations other than FHSS, the maximum RF output power shall be equal to or less than the value declared by the supplier.

This limit shall apply for any combination of power level and intended antenna assembly.

3.2 Test Procedure

According to section 5.4.2.2.1.2 of the standard EN 300328, the test procedure shall be as follows:

Step 1:

- Use a fast power sensor suitable for 2,4 GHz and capable of 1 MS/s.
- Use the following settings: - Sample speed 1 MS/s or faster.
- The samples must represent the power of the signal.
- Measurement duration: For non-adaptive equipment: equal to the observation period defined in clauses 4.3.1.3.2 or clause 4.3.2.4.2. For adaptive equipment, the measurement duration shall be long enough to ensure a minimum number of bursts (at least 10) are captured.

NOTE 1: For adaptive equipment, to increase the measurement accuracy, a higher number of bursts may be used.

Step 2:

- For conducted measurements on devices with one transmit chain:
 - Connect the power sensor to the transmit port, sample the transmit signal and store the raw data. Use these stored samples in all following steps.
- For conducted measurements on devices with multiple transmit chains:
 - Connect one power sensor to each transmit port for a synchronous measurement on all transmit ports.
 - Trigger the power sensors so that they start sampling at the same time. Make sure the time difference between the samples of all sensors is less than half the time between two samples.
 - For each individual sampling point (time domain), sum the coincident power samples of all ports and store them. Use these summed samples in all following steps..

Step 3:

- Find the start and stop times of each burst in the stored measurement samples.

The start and stop times are defined as the points where the power is at least 30 dB below the highest value of



the stored samples in step 2.

NOTE 2: In case of insufficient dynamic range, the value of 30 dB may need to be reduced appropriately.

Step 4:

- Between the start and stop times of each individual burst calculate the RMS power over the burst using the formula below. Save these Pburst values, as well as the start and stop times for each burst.

$$P_{burst} = \frac{1}{k} \sum_{n=1}^k P_{sample}(n)$$

with 'k' being the total number of samples and 'n' the actual sample number

Step 5:

- The highest of all Pburst values (value "A" in dBm) will be used for maximum e.i.r.p. calculations.

Step 6:

- Add the (stated) antenna assembly gain "G" in dBi of the individual antenna.
- If applicable, add the additional beamforming gain "Y" in dB.
- If more than one antenna assembly is intended for this power setting, the maximum overall antenna gain (G or G + Y) shall be used.
- The RF Output Power (P) shall be calculated using the formula below: $P = A + G + Y$
- This value, which shall comply with the limit given in clause 4.3.1.2.3 or clause 4.3.2.2.3, shall be recorded in the test report.

3.3 Summary of Test Results

BDR/EDR				
Test conditions	Modulation	EIRP (dBm)	Limit (dBm)	Result
NTNV	GFSK	4.29	20.00	Pass
	$\pi/4$ QPSK	4.19		
	8DPSK	4.33		
LTVN	GFSK	4.25		
	$\pi/4$ QPSK	4.16		
	8DPSK	4.31		
HTNV	GFSK	4.25		
	$\pi/4$ QPSK	4.17		
	8DPSK	4.32		

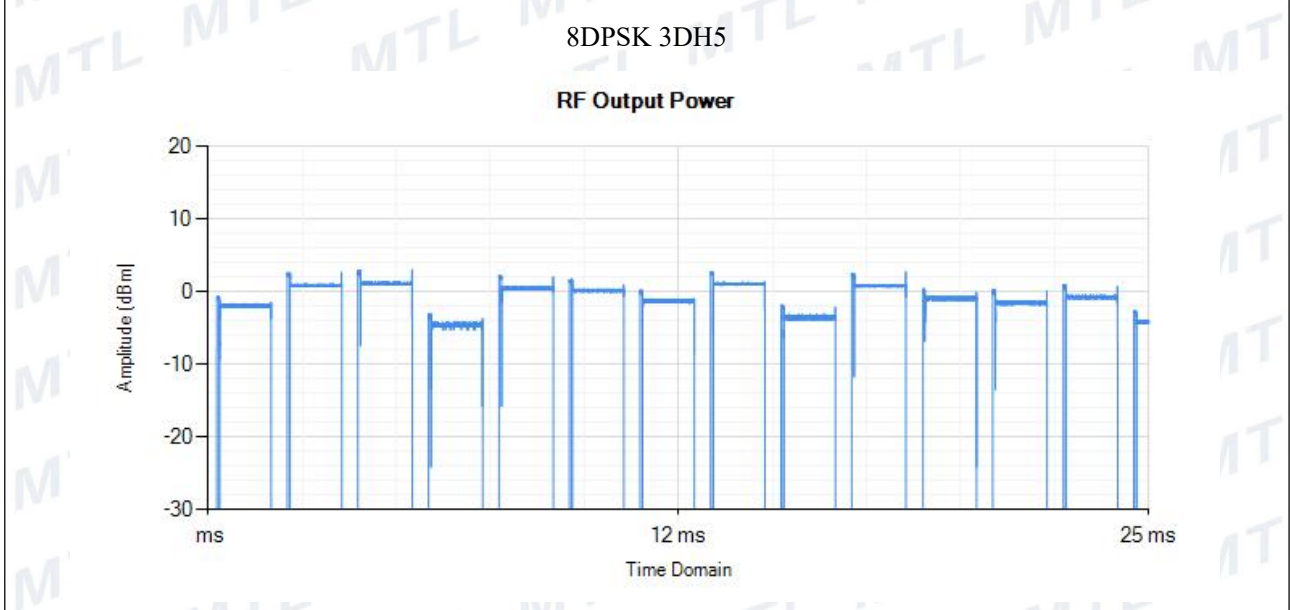
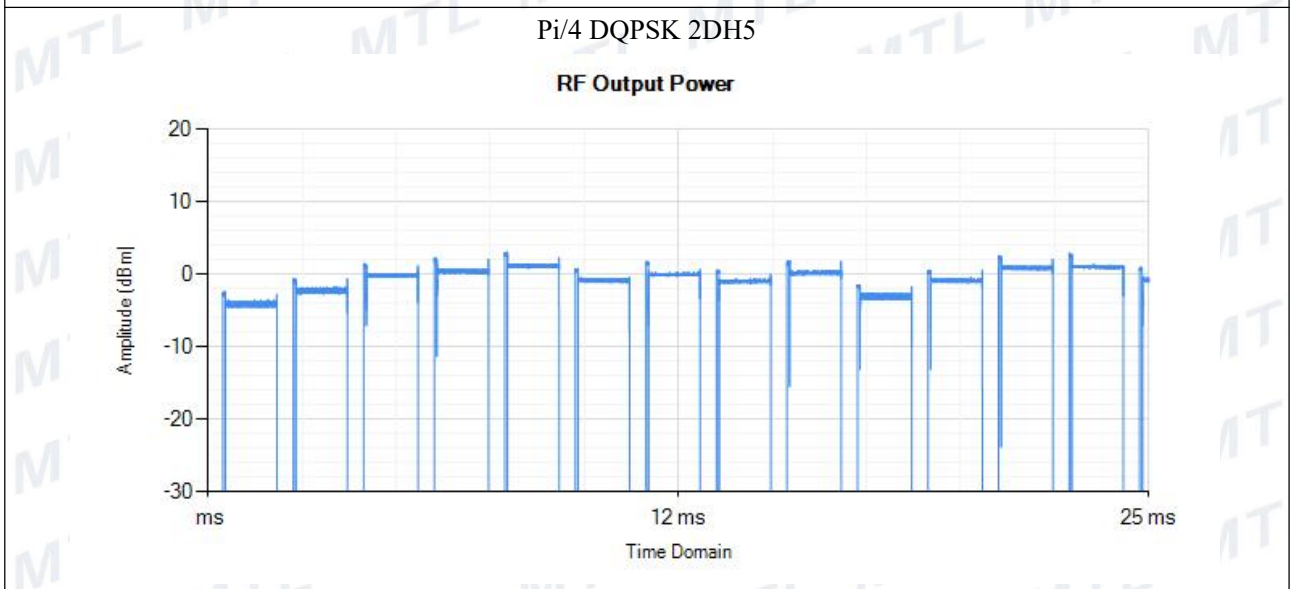
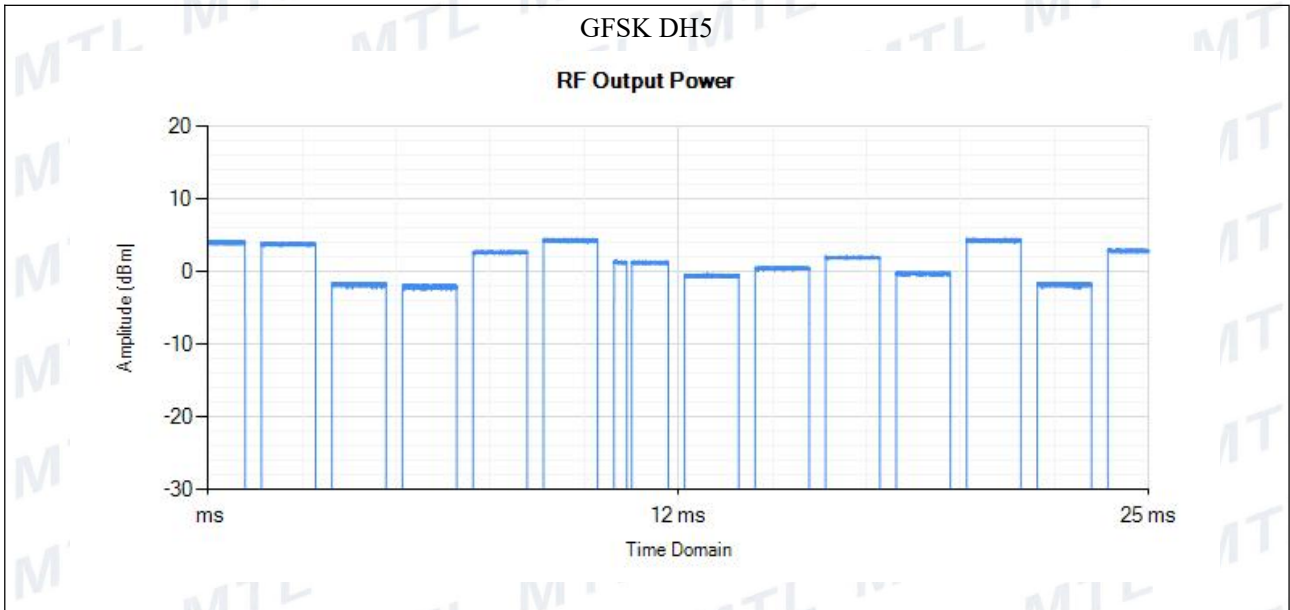



4. Accumulated Transmit Time, Frequency Occupation and Hopping Sequence

4.1 Standard Application

According to section 4.3.1.4.3,

Adaptive Frequency Hopping equipment shall be capable of operating over a minimum of 70 % of the band specified in clause 1.

The Accumulated Transmit Time on any hopping frequency shall not be greater than 400 ms within any observation period of 400 ms multiplied by the minimum number of hopping frequencies (N) that have to be used.

In order for the equipment to comply with the Frequency Occupation requirement, it shall meet either of the following two options:

Option 1: Each hopping frequency of the hopping sequence shall be occupied at least once within a period not exceeding four times the product of the dwell time and the number of hopping frequencies in use.

Option 2: The occupation probability for each frequency shall be between $((1 / U) \times 25 \%)$ and 77 % where U is the number of hopping frequencies in use.

The hopping sequence(s) shall contain at least N hopping frequencies at all times, where N is 15 or 15 divided by the minimum Hopping Frequency Separation in MHz, whichever is the greater.

4.2 Test procedure

According to section 5.4.4.2.1, the test procedure shall be as follows:

Step 1:

- The output of the transmitter shall be connected to a spectrum analyzer or equivalent.
- The analyzer shall be set as follows:
 - Centre Frequency: Equal to the hopping frequency being investigated
 - Frequency Span: 0 Hz
 - RBW: $\sim 50 \%$ of the Occupied Channel Bandwidth
 - VBW: \geq RBW
 - Detector Mode: RMS
 - Sweep time: Equal to the applicable observation period (see clause 4.3.1.4.3.1 or clause 4.3.1.4.3.2)
 - Number of sweep points: 30 000
 - Trace mode: Clear / Write
 - Trigger: Free Run

Step 2:

- Save the trace data to a file for further analysis by a computing device using an appropriate software application or program.

Step 3:

- Identify the data points related to the frequency being investigated by applying a threshold.

The data points resulting from transmissions on the hopping frequency being investigated are assumed to have much higher levels compared to data points resulting from transmissions on adjacent hopping frequencies. If a



clear determination between these transmissions is not possible, the RBW in step 1 shall be further reduced. In addition, a channel filter may be used.

- Count the number of data points identified as resulting from transmissions on the frequency being investigated and multiply this number by the time difference between two consecutive data points.

Step 4:

- The result in step 3 is the accumulated Dwell Time which shall comply with the limit provided in clauses 4.3.1.4.3.1 or 4.3.1.4.3.2 and which shall be recorded in the test report.

Step 5:

NOTE 1: This step is only applicable for equipment implementing Option 1 in clause 4.3.1.4.3.1 or clause 4.3.1.4.3.2 for complying with the Frequency Occupation requirement and the manufacturer decides to demonstrate compliance with this requirement via measurement.

- Make the following changes on the analyser and repeat step 2 and step 3.

Sweep time: $4 \times \text{Dwell Time} \times \text{Actual number of hopping frequencies in use}$

The hopping frequencies occupied by the equipment without having transmissions during the dwell time (blacklisted frequencies) should be taken into account in the actual number of hopping frequencies in use. If this number cannot be determined (number of blacklisted frequencies unknown) it shall be assumed that the equipment uses the maximum possible number of hopping frequencies.

- The result shall be compared to the limit for the Frequency Occupation defined in clause 4.3.1.4.3.1 or clause 4.3.1.4.3.2. The result of this comparison shall be recorded in the test report.

Step 6:

- Make the following changes on the analyzer:

- Start Frequency: 2 400 MHz
- Stop Frequency: 2 483,5 MHz
- RBW: ~ 50 % of the Occupied Channel Bandwidth (single hopping frequency)
- VBW: \geq RBW
- Detector Mode: RMS
- Sweep time: 1s
- Trace Mode: Max Hold
- Trigger: Free Run

NOTE 2: The above sweep time setting may result in long measuring times. To avoid such long measuring times, an FFT analyser could be used.

- Wait for the trace to stabilize. Identify the number of hopping frequencies used by the hopping sequence.
- The result shall be compared to the limit (value N) defined in clause 4.3.1.4.3.1 or clause 4.3.1.4.3.2. This value shall be recorded in the test report.

For equipment with blacklisted frequencies, it might not be possible to verify the number of hopping frequencies in use. However they shall comply with the requirement for Accumulated Transmit Time and Frequency Occupation assuming the minimum number of hopping frequencies (N) defined in clause 4.3.1.4.3.1 or clause 4.3.1.4.3.2 is used.



Step 7:

- For adaptive systems, using the lowest and highest -20 dB points from the total spectrum envelope obtained in step 6, it shall be verified whether the system uses 70 % of the band specified in clause 1. The result shall be recorded in the test report.

RBW/RBW=500/500kHz

4.3 Summary of Test Results/Plots

Modulation	Test Channel	Packet	Maximum Accumulated Dwell Time	
			Acc. Dwell Time	Limit
			ms	ms
GFSK	2402MHz	DH5	129.60	<400
	2480MHz	DH5	161.28	<400
Test Period: 400ms X Minimum number of hopping frequencis (N)				
Accumulated Dwell Time = Time slot length (Dwell time) X Number of data points within a test period				
Note: Test data is corrected with the worse case, which the packet length is GFSK DH5				

Modulation	Test Channel	Packet	Frequency Occupation requirement	
			Burst Number	Limit(Burst Number)
GFSK	2402MHz	DH1	3	≥ 1
	2480MHz	DH1	2	≥ 1
Test Period: 4 X Dwell time X Minimum number of hopping frequencies (N)				
Occupation Time = Time slot length (Dwell time) X Number of data points within a test period				
Note: Test data is corrected with the worst case, which the packet length is GFSK DH5				

Frequency Band	Number of Hopping Frequencies (N)	Limit	Result
2400-2483.5MHz	79	15	Passed
	Band Allocation(%)	Limit Band Allocation(%)	Result
	94.87	≥70	Passed



5. Hopping Frequency Separation

5.1 Standard Application

According to section 4.3.1.5.3,

For adaptive Frequency Hopping equipment, the minimum Hopping Frequency Separation shall be 100 kHz.

Adaptive Frequency Hopping equipment, which for one or more hopping frequencies, has switched to a non-adaptive mode because interference was detected on all these hopping positions with a level above the threshold level defined in clause 4.3.1.7.2.2 or clause 4.3.1.7.3.2, is allowed to continue to operate with a minimum Hopping Frequency Separation of 100 kHz on these hopping frequencies as long as the interference is present on these frequencies. The equipment shall continue to operate in an adaptive mode on other hopping frequencies.

Adaptive Frequency Hopping equipment which decided to operate in a non-adaptive mode on one or more hopping frequencies without the presence of interference, shall comply with the limit in clause 4.3.1.5.3.1 for these hopping frequencies as well as with all other requirements applicable to non-adaptive frequency hopping equipment.

5.2 Test procedure

According to the section 5.4.5.2.1, the option 2 test method shall be used.

Step 1:

The output of the transmitter shall be connected to a spectrum analyzer or equivalent.

The analyzer shall be set as follows:

- Centre Frequency: Centre of the two adjacent hopping frequencies
- Frequency Span: Sufficient to see the complete power envelope of both hopping frequencies
- RBW: 1 % of the Span
- VBW: $3 \times \text{RBW}$
- Detector Mode: RMS
- Trace Mode: Max Hold
- Sweep Time: 1s

NOTE: Depending on the nature of the signal (modulation), it might be required to use a much longer sweep time, e.g. in case switching transients are present in the signals to be investigated.

Step 2:

- Wait for the trace to stabilize.
- Use the marker-delta function to determine the Hopping Frequency Separation between the centres of the two adjacent hopping frequencies (e.g. by indentifying peaks or notches at the centre of the power envelope for the two adjacent signals). This value shall be compared with the limits defined in clause 4.3.1.5.3 and shall be recorded in the test report.

RBW/VBW=30/100kHz



5.3 Summary of Test Results/Plots

Test Mode	Test Channel	Adjacent Channel	Channel Separation	Limit
	MHz	MHz	MHz	MHz
GFSK	2402	2403	1001	>0.1
	2480	2479	1001	>0.1
8DPSK	2402	2403	1002	>0.1
	2480	2479	1002	>0.1



6. Occupied Channel Bandwidth

6.1 Standard Application

According to section 4.3.1.8.3, the Occupied Channel Bandwidth for each hopping frequency shall fall completely within the band given in clause 1.

For non-adaptive Frequency Hopping equipment with e.i.r.p greater than 10 dBm, the Occupied Channel Bandwidth for every occupied hopping frequency shall be equal to or less than the value declared by the supplier. This declared value shall not be greater than 5 MHz.

According to section 4.3.2.7.3, the Occupied Channel Bandwidth shall fall completely within the band given in clause 1. In addition, for non-adaptive systems using wide band modulations other than FHSS and with e.i.r.p greater than 10 dBm, the occupied channel bandwidth shall be less than 20 MHz.

6.2 Test procedure

According to the section 5.4.7.2.1, the measurement procedure shall be as follows:

Step 1:

Connect the UUT to the spectrum analyser and use the following settings:

- Centre Frequency: The centre frequency of the channel under test
- Resolution BW: $\sim 1\%$ of the span without going below 1%
- Video BW: $3 \times \text{RBW}$
- Frequency Span for frequency hopping equipment: Lowest frequency separation that is used within the hopping sequence
- Frequency Span for other types of equipment: $2 \times \text{Nominal Channel Bandwidth}$ (e.g. 40 MHz for a 20 MHz channel)
- Detector Mode: RMS
- Trace Mode: Max Hold
- Sweep time: 1 s

Step 2:

Wait until the trace is completed.

Find the peak value of the trace and place the analyser marker on this peak.

Step 3:

Use the 99% bandwidth function of the spectrum analyser to measure the Occupied Channel Bandwidth of the UUT. This value shall be recorded.



6.3 Summary of Test Results/Plots

Mode	Channel	Measured Frequency (MHz)		Limit (MHz)	Result
		Low	High		
GFSK	Low	2401.565	2402.415	2400.00~2483.50	Pass
	High	2479.560	2480.400		
$\pi/4$ QPSK	Low	2401.445	2402.515	2400.00~2483.50	Pass
	High	2479.445	2480.515		
8DPSK	Low	2401.450	2402.510	2400.00~2483.50	Pass
	High	2479.450	2480.510		

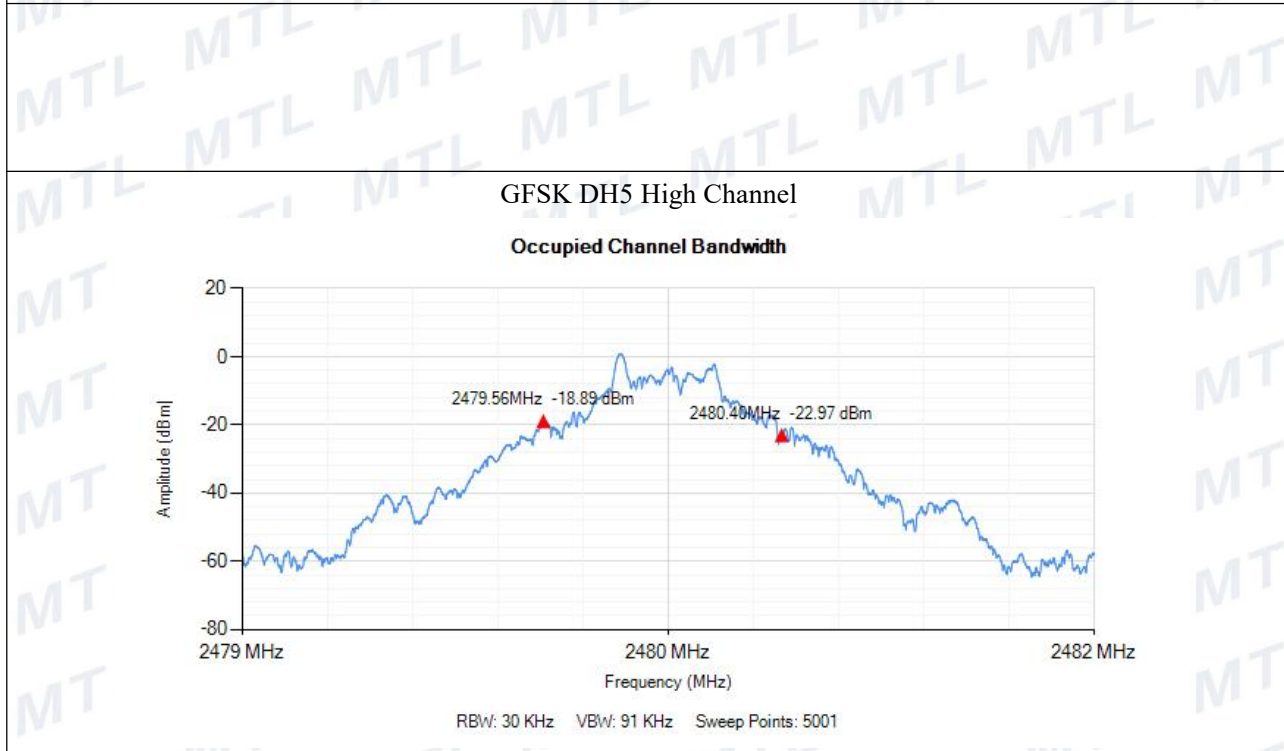
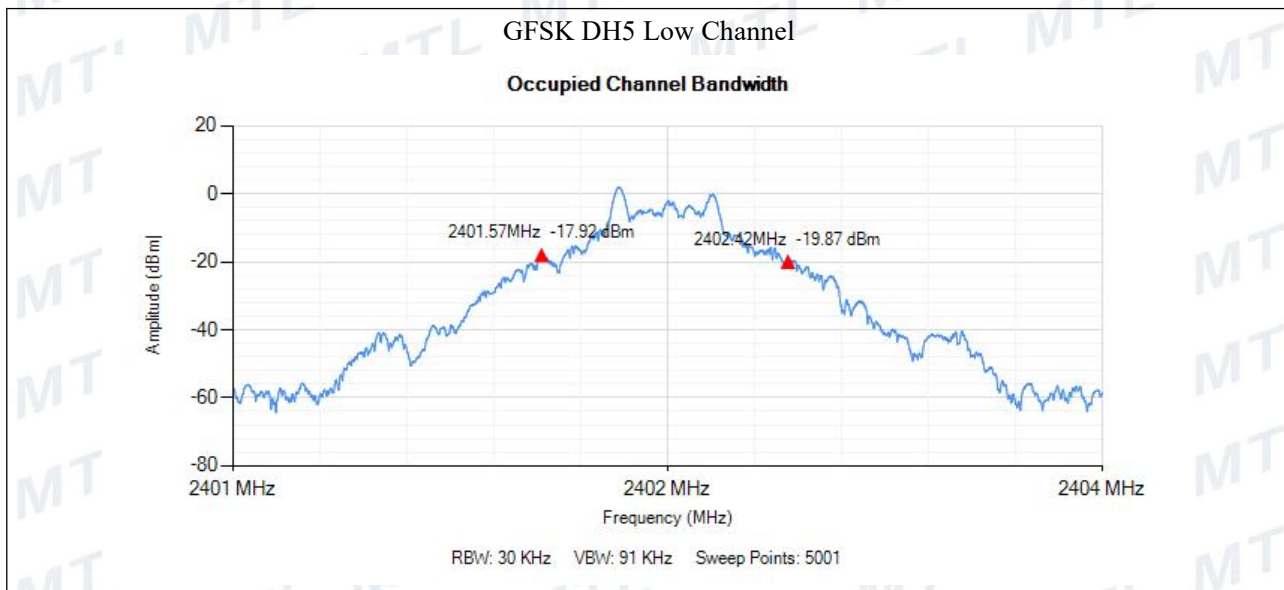

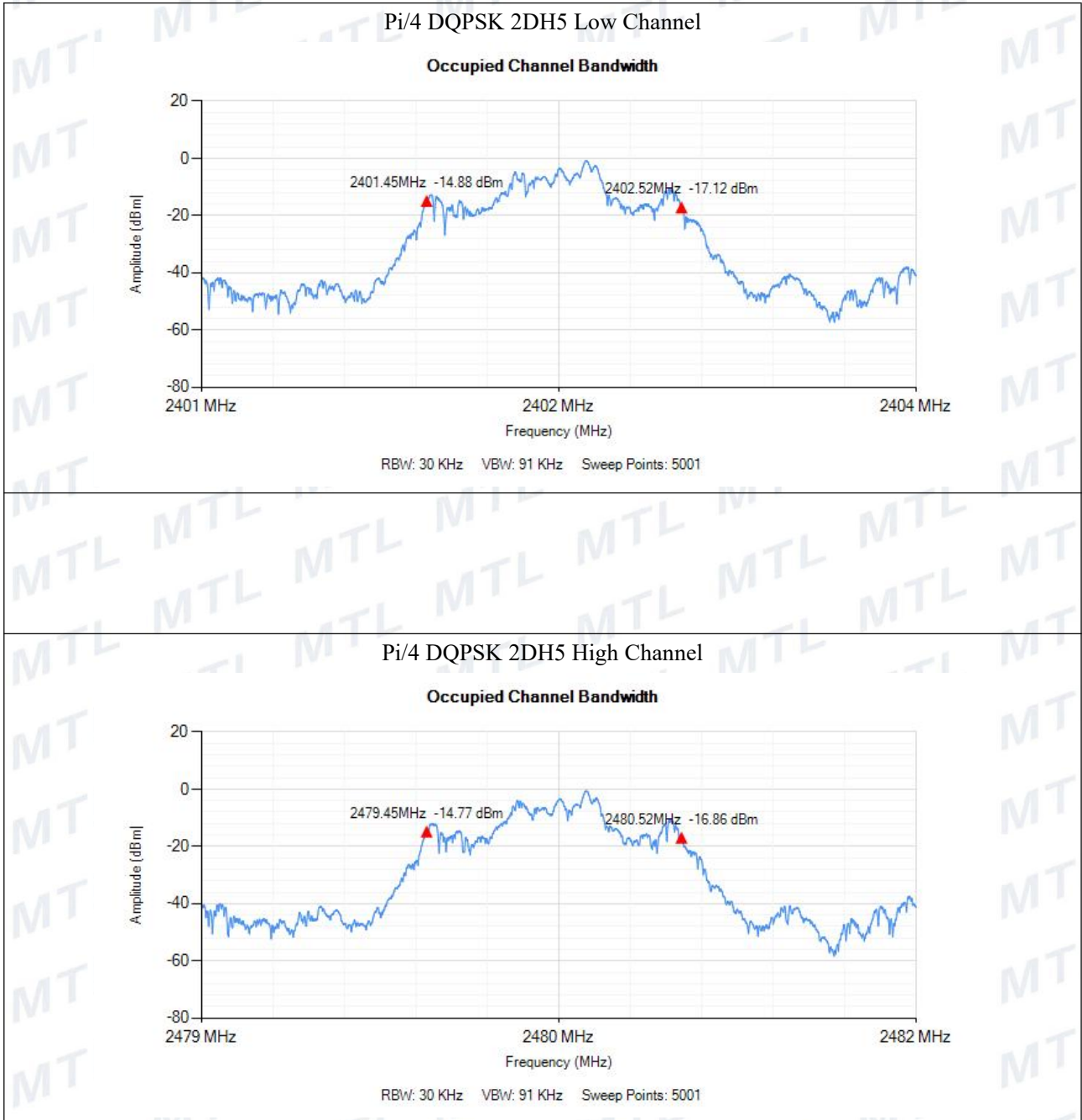

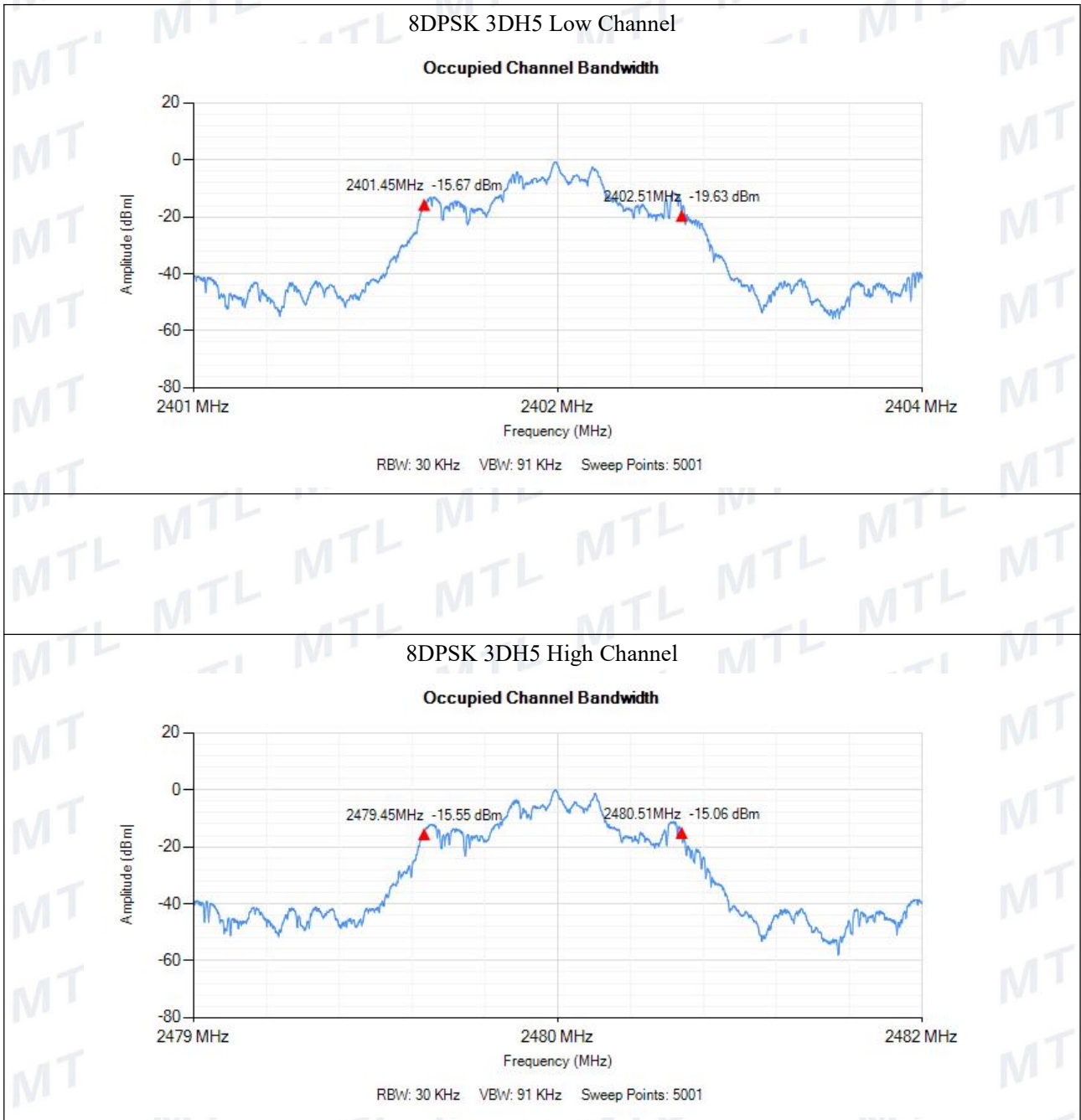

7. Transmitter Unwanted Emissions in the Out-of-band Domain

7.1 Standard Application

According to section 4.3.1.9.3&4.3.2.8.3, the transmitter unwanted emissions in the out-of-band domain but outside the allocated band, shall not exceed the values provided by the mask in figure below

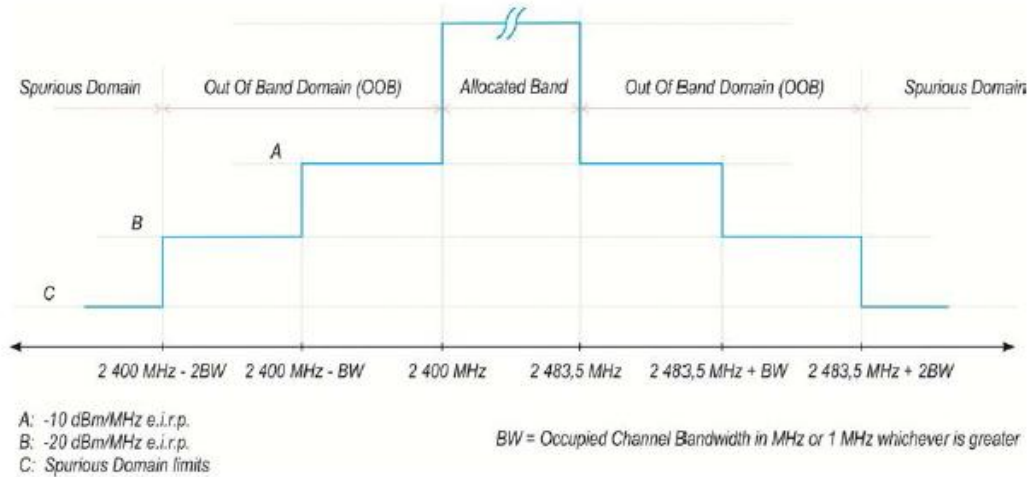

Within the 2 400 MHz to 2 483,5 MHz band, the Out-of-band emissions are fulfilled by compliance with the Occupied Channel Bandwidth requirement

7.2 Test procedure

According to the section 5.4.8.2.1, the measurement procedure shall be as follows:

The Out-of-band emissions within the different horizontal segments of the mask provided in figures 1 and 3 shall be measured using the steps below. This method assumes the spectrum analyser is equipped with the Time Domain Power option.

Step 1:

- Connect the UUT to the spectrum analyser and use the following settings:
 - Centre Frequency: 2 484 MHz
 - Span: 0 Hz
 - Resolution BW: 1 MHz
 - Filter mode: Channel filter
 - Video BW: 3 MHz
 - Detector Mode: RMS
 - Trace Mode: Max Hold
 - Sweep Mode: Continuous
 - Sweep Points: Sweep Time [s] / (1 μ s) or 5 000 whichever is greater
 - Trigger Mode: Video trigger

NOTE 1: In case video triggering is not possible, an external trigger source may be used.

- Sweep Time: > 120 % of the duration of the longest burst detected during the measurement of the RF Output Power

**Step 2:** (segment 2 483,5 MHz to 2 483,5 MHz + BW)

- Adjust the trigger level to select the transmissions with the highest power level.
- For frequency hopping equipment operating in a normal hopping mode, the different hops will result in signal bursts with different power levels. In this case the burst with the highest power level shall be selected.
- Set a window (start and stop lines) to match with the start and end of the burst and in which the RMS power shall be measured using the Time Domain Power function.
- Select RMS power to be measured within the selected window and note the result which is the RMS power within this 1 MHz segment (2 483,5 MHz to 2 484,5 MHz). Compare this value with the applicable limit provided by the mask.
- Increase the centre frequency in steps of 1 MHz and repeat this measurement for every 1 MHz segment within the range 2 483,5 MHz to 2 483,5 MHz + BW. The centre frequency of the last 1 MHz segment shall be set to 2 483,5 MHz + BW - 0,5 MHz (which means this may partly overlap with the previous 1 MHz segment).

Step 3: (segment 2 483,5 MHz + BW to 2 483,5 MHz + 2BW)

- Change the centre frequency of the analyser to 2 484 MHz + BW and perform the measurement for the first 1 MHz segment within range 2 483,5 MHz + BW to 2 483,5 MHz + 2BW. Increase the centre frequency in 1 MHz steps and repeat the measurements to cover this whole range. The centre frequency of the last 1 MHz segment shall be set to 2 483,5 MHz + 2 BW - 0,5 MHz.

Step 4: (segment 2 400 MHz - BW to 2 400 MHz)

- Change the centre frequency of the analyser to 2 399,5 MHz and perform the measurement for the first 1 MHz segment within range 2 400 MHz - BW to 2 400 MHz. Reduce the centre frequency in 1 MHz steps and repeat the measurements to cover this whole range. The centre frequency of the last 1 MHz segment shall be set to 2 400 MHz - 2BW + 0,5 MHz.

Step 5: (segment 2 400 MHz - 2BW to 2 400 MHz - BW)

- Change the centre frequency of the analyser to 2 399,5 MHz - BW and perform the measurement for the first 1 MHz segment within range 2 400 MHz - 2BW to 2 400 MHz - BW. Reduce the centre frequency in 1 MHz steps and repeat the measurements to cover this whole range. The centre frequency of the last 1 MHz segment shall be set to 2 400 MHz - 2BW + 0,5 MHz.

Step 6:

- In case of conducted measurements on equipment with a single transmit chain, the declared antenna assembly gain "G" in dBi shall be added to the results for each of the 1 MHz segments and compared with the limits provided by the mask given in figure 1 or figure 3. If more than one antenna assembly is intended for this power setting, the antenna with the highest gain shall be considered.
- In case of conducted measurements on smart antenna systems (equipment with multiple transmit chains), the measurements need to be repeated for each of the active transmit chains. The declared antenna assembly gain "G" in dBi for a single antenna shall be added to these results. If more than one antenna assembly is intended for this power setting, the antenna with the highest gain shall be considered. Comparison with the applicable limits shall be done using any of the options given below:
 - Option 1: the results for each of the transmit chains for the corresponding 1 MHz segments shall be added. The additional beamforming gain "Y" in dB shall be added as well and the resulting values



compared with the limits provided by the mask given in figure 1 or figure 3.

NOTE 2: A ch refers to the number of active transmit chains.

It shall be recorded whether the equipment complies with the mask provided in figure 1 or figure 3.

RBW=1MHz VBW=3MHz

7.3 Summary of Test Results/Plots

Test CH.	Test Segment	Max. Emissions Reading (dBm)	Limit
	MHz	Normal	dBm
Test Mode: GFSK DH5			
Low	2400-BW to 2400	-53.279	-10
	2400-2BW to 2400-BW	-57.589	-20
High	2483.5 to 2483.5+BW	-60.520	-10
	2483.5+BW to 2483.5+2BW	-61.430	-20
Test Mode: Pi/4 DQPSK 2DH5			
Low	2400-BW to 2400	-52.989	-10
	2400-2BW to 2400-BW	-57.289	-20
High	2483.5 to 2483.5+BW	-59.420	-10
	2483.5+BW to 2483.5+2BW	-60.530	-20
Test Mode: 8DPSK 3DH5			
Low	2400-BW to 2400	-54.849	-10
	2400-2BW to 2400-BW	-58.839	-20
High	2483.5 to 2483.5+BW	-61.090	-10
	2483.5+BW to 2483.5+2BW	-61.710	-20
Note 1: BW please refer to section 7.3			
Note 2: the data just list the worst cases			

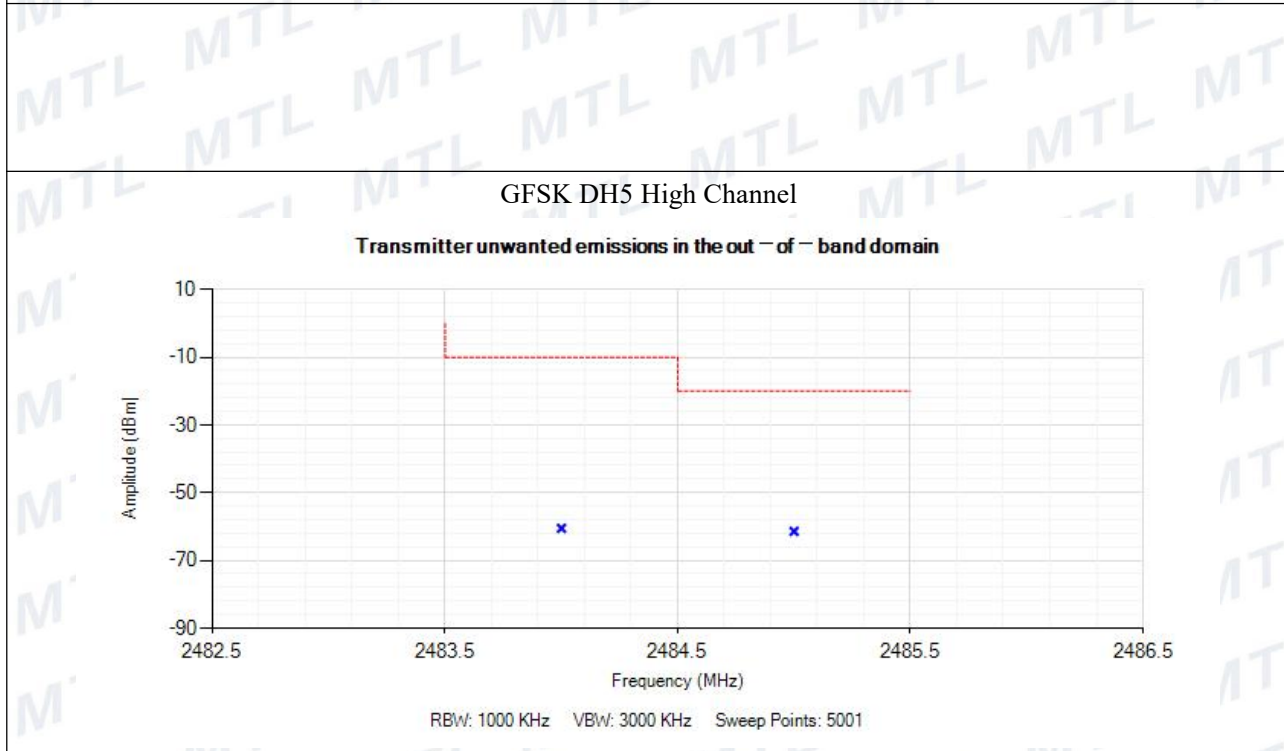
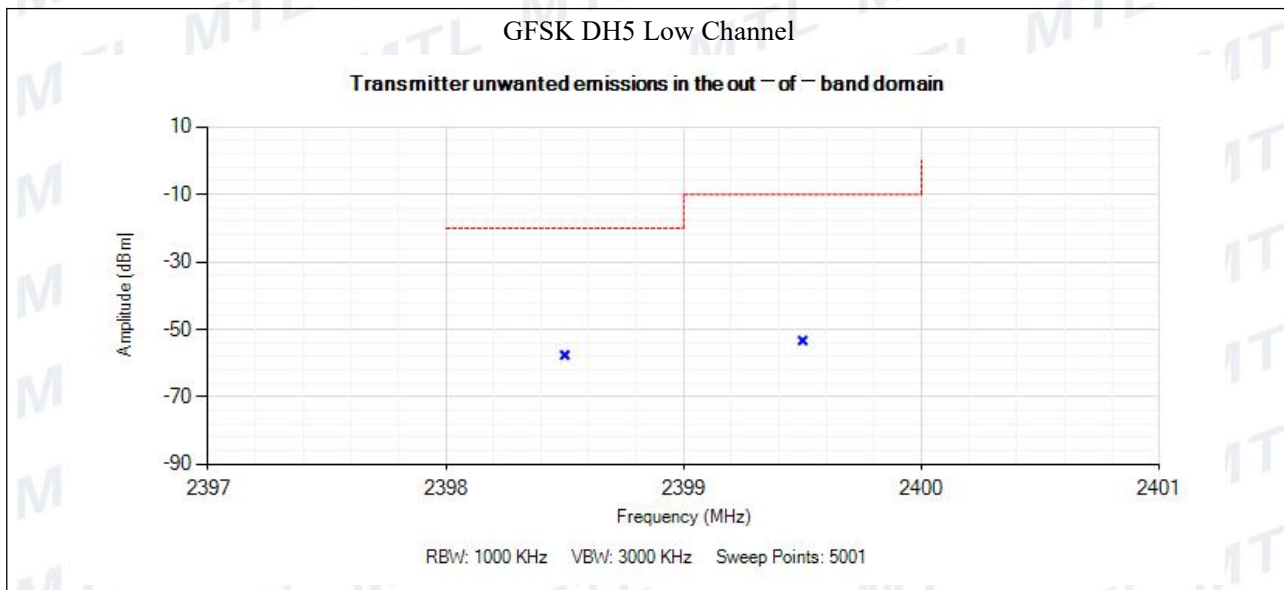

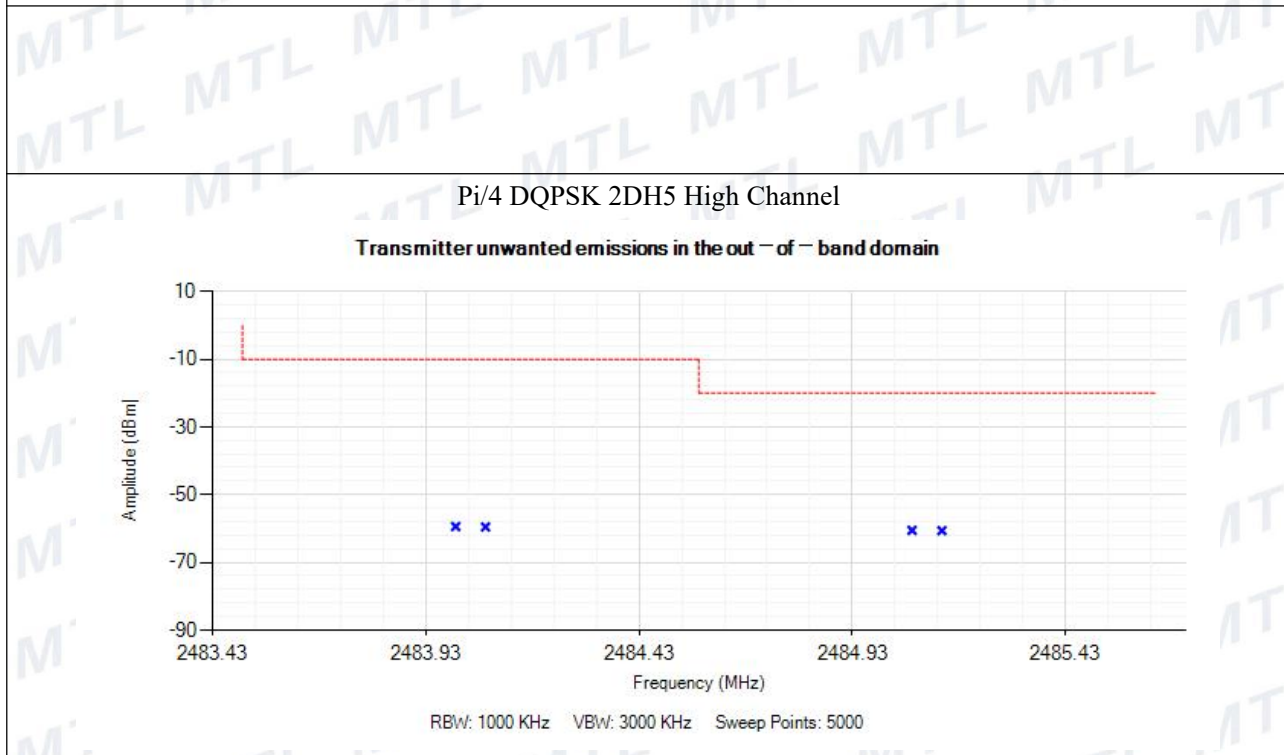
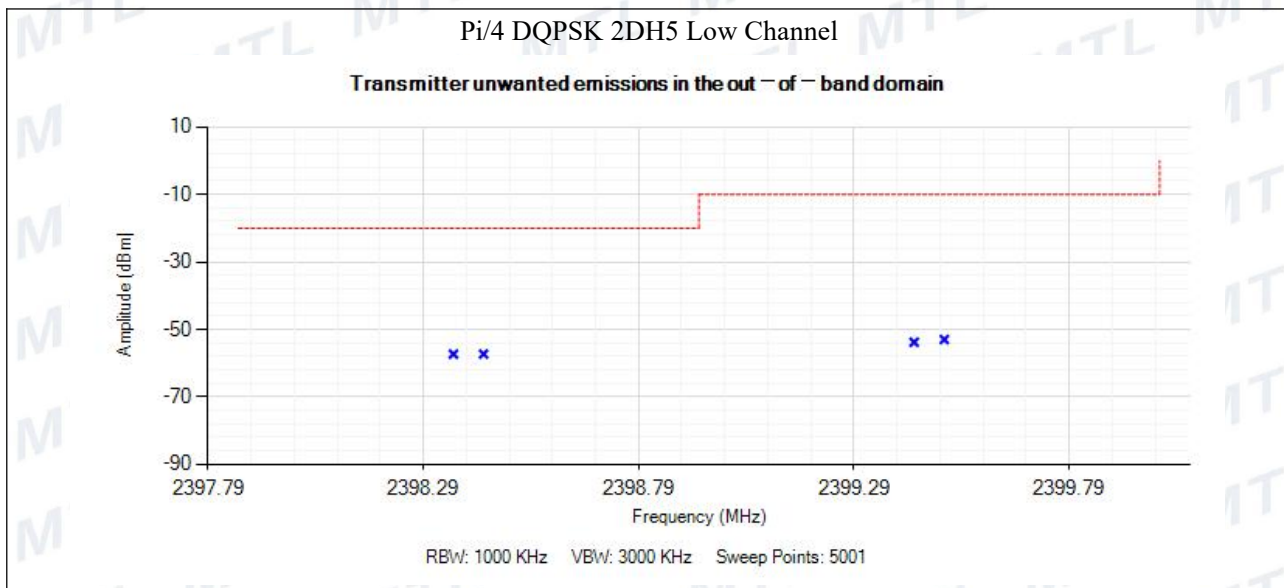

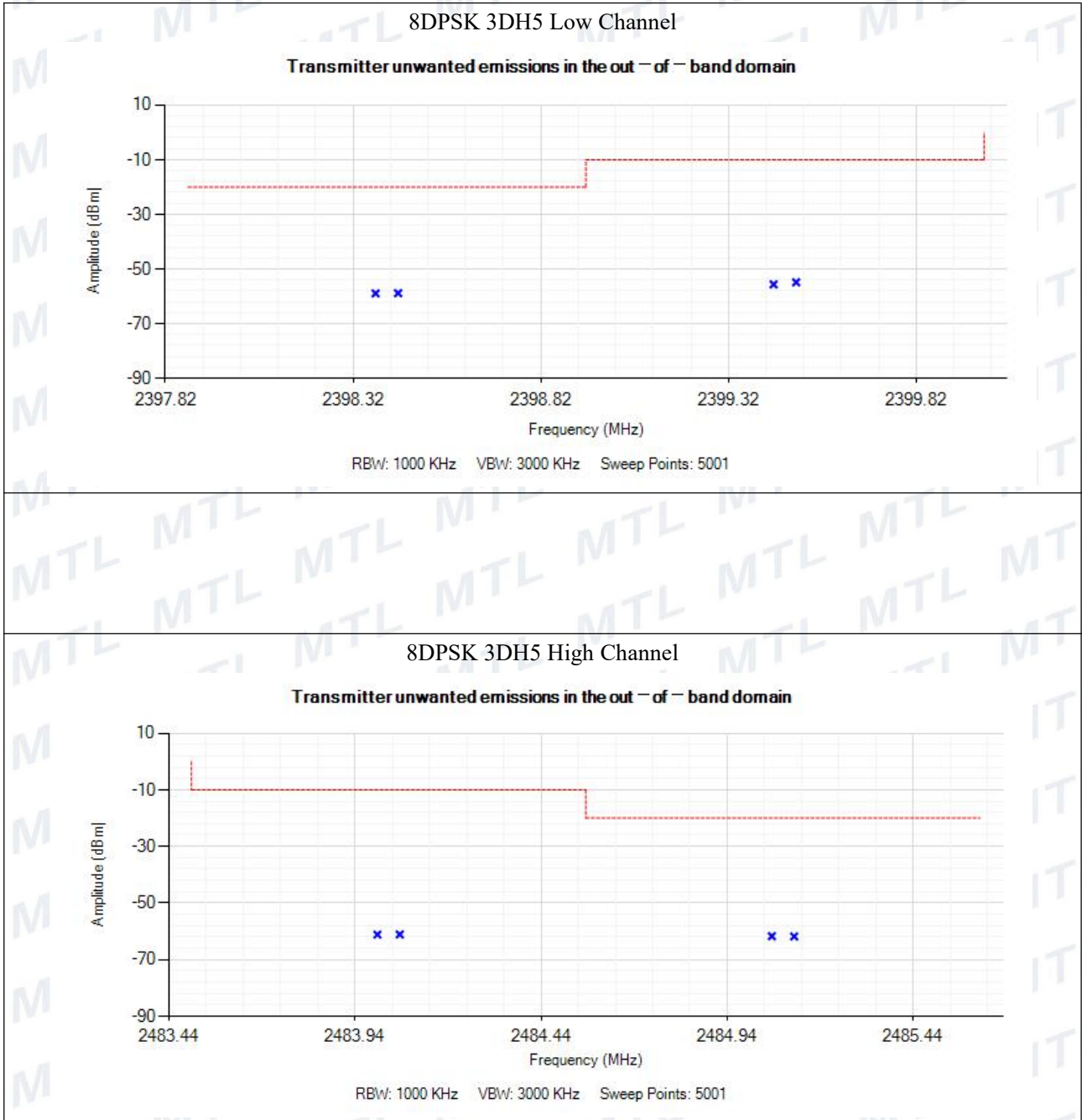



8. Transmitter Unwanted Emissions in the Spurious Domain

8.1 Standard Applicable

According to section 4.3.1.10.3& 4.3.2.9.3,

The transmitter unwanted emissions in the spurious domain shall not exceed the values given in the following table.

Frequency range	Maximum power	Bandwidth
30 MHz to 47 MHz	-36 dBm	100 kHz
47 MHz to 74 MHz	-54 dBm	100 kHz
74 MHz to 87,5 MHz	-36 dBm	100 kHz
87,5 MHz to 118 MHz	-54 dBm	100 kHz
118 MHz to 174 MHz	-36 dBm	100 kHz
174 MHz to 230 MHz	-54 dBm	100 kHz
230 MHz to 470 MHz	-36 dBm	100 kHz
470 MHz to 862 MHz	-54 dBm	100 kHz
862 MHz to 1 GHz	-36 dBm	100 kHz
1 GHz to 12,75 GHz	-30 dBm	1 MHz

8.2 Test Procedure

The device under test has an integral antenna and the radiated measurement shall apply to the device, using the method of measurement as described in the EN300328 section 5.4.9.2

RBW=100kHz VBW=300kHz 30MHz-1GHz
RBW=1MHz VBW=3MHz 1GHz-12.75GHz

8.3 Summary of Test Results/Plots

According to the data, the EUT complied with the EN 300328 standards, and had the worst cases:



➤ Spurious Emission From 30MHz To 1GHz
For EDR

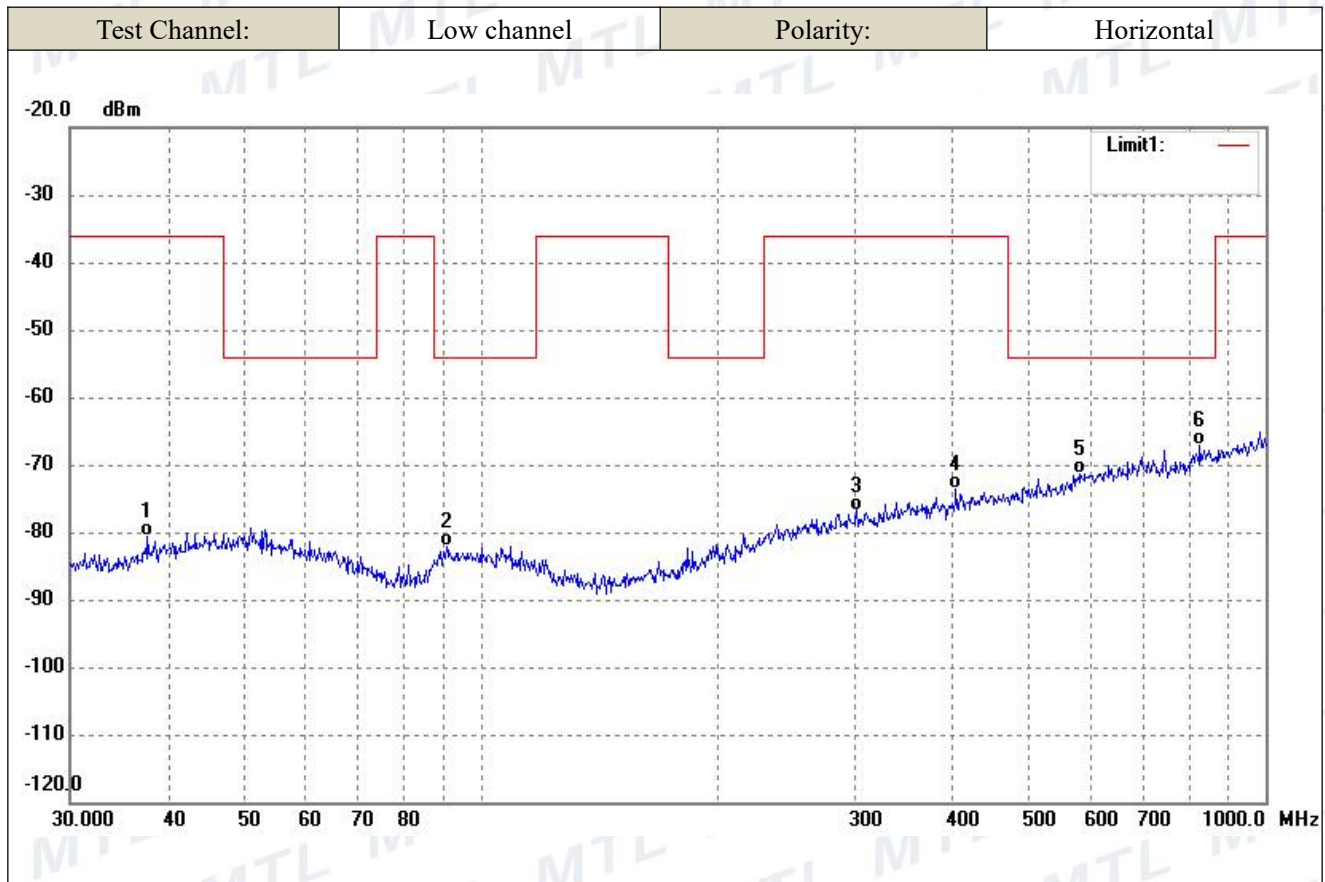

No.	Frequency (MHz)	Reading (dBm)	Correct Factor(dB)	Result (dBm)	Limit (dBm)	Margin (dB)	Remark
1	37.6798	-79.16	-1.53	-80.69	-36.00	-44.69	ERP
2	90.5374	-80.47	-1.71	-82.18	-54.00	-28.18	ERP
3	301.4224	-80.38	3.63	-76.75	-36.00	-40.75	ERP
4	403.2500	-78.78	5.14	-73.64	-36.00	-37.64	ERP
5	580.7026	-79.47	8.11	-71.36	-54.00	-17.36	ERP
6	824.5968	-78.56	11.49	-67.07	-54.00	-13.07	ERP

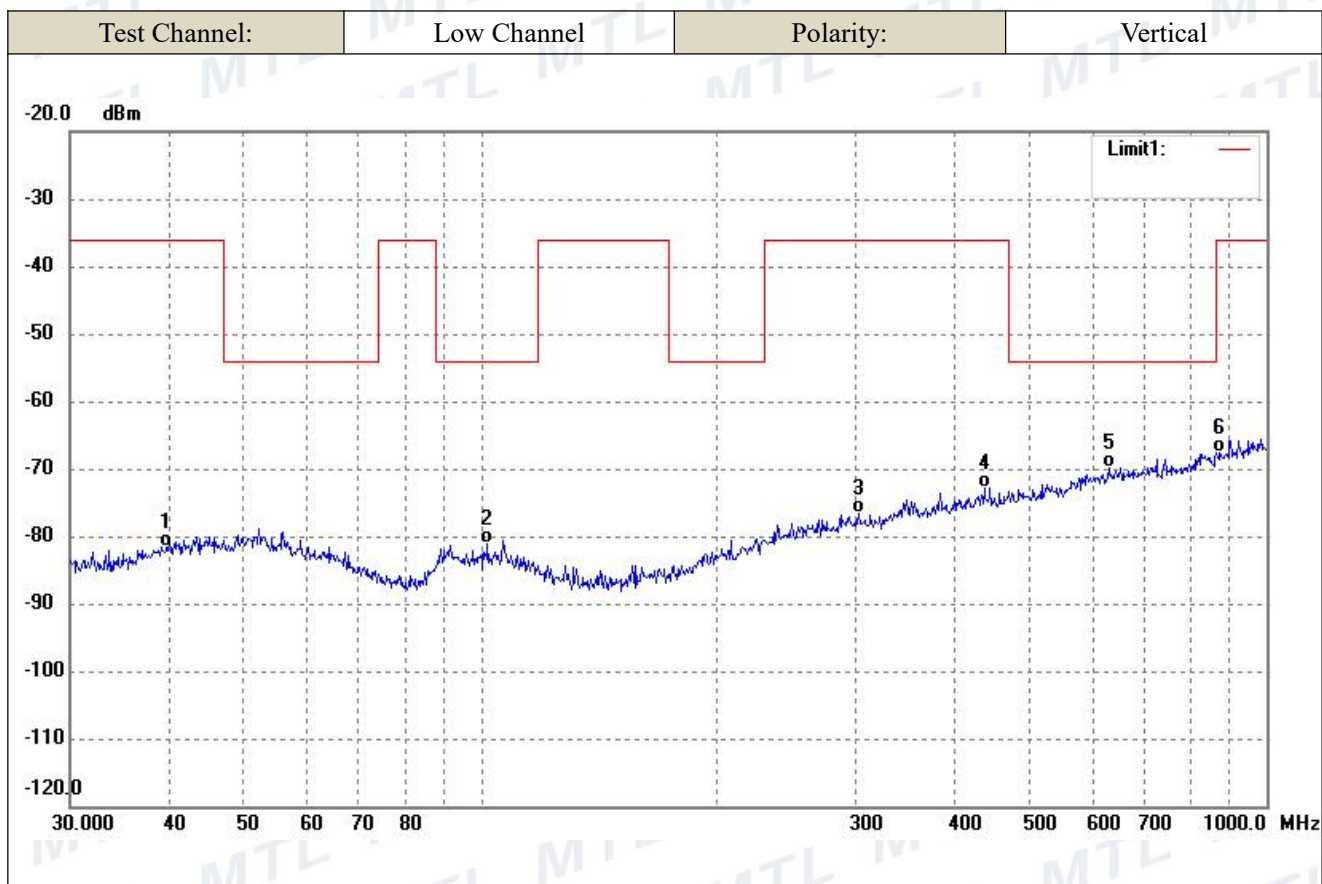

No.	Frequency (MHz)	Reading (dBm)	Correct Factor(dB)	Result (dBm)	Limit (dBm)	Margin (dB)	Remark
1	39.8542	-80.58	-0.92	-81.50	-36.00	-45.50	ERP
2	102.0014	-79.30	-1.83	-81.13	-54.00	-27.13	ERP
3	302.4812	-80.24	3.61	-76.63	-36.00	-40.63	ERP
4	437.1199	-78.57	5.72	-72.85	-36.00	-36.85	ERP
5	629.4772	-78.93	9.06	-69.87	-54.00	-15.87	ERP
6	869.1302	-79.74	12.18	-67.56	-36.00	-31.56	ERP

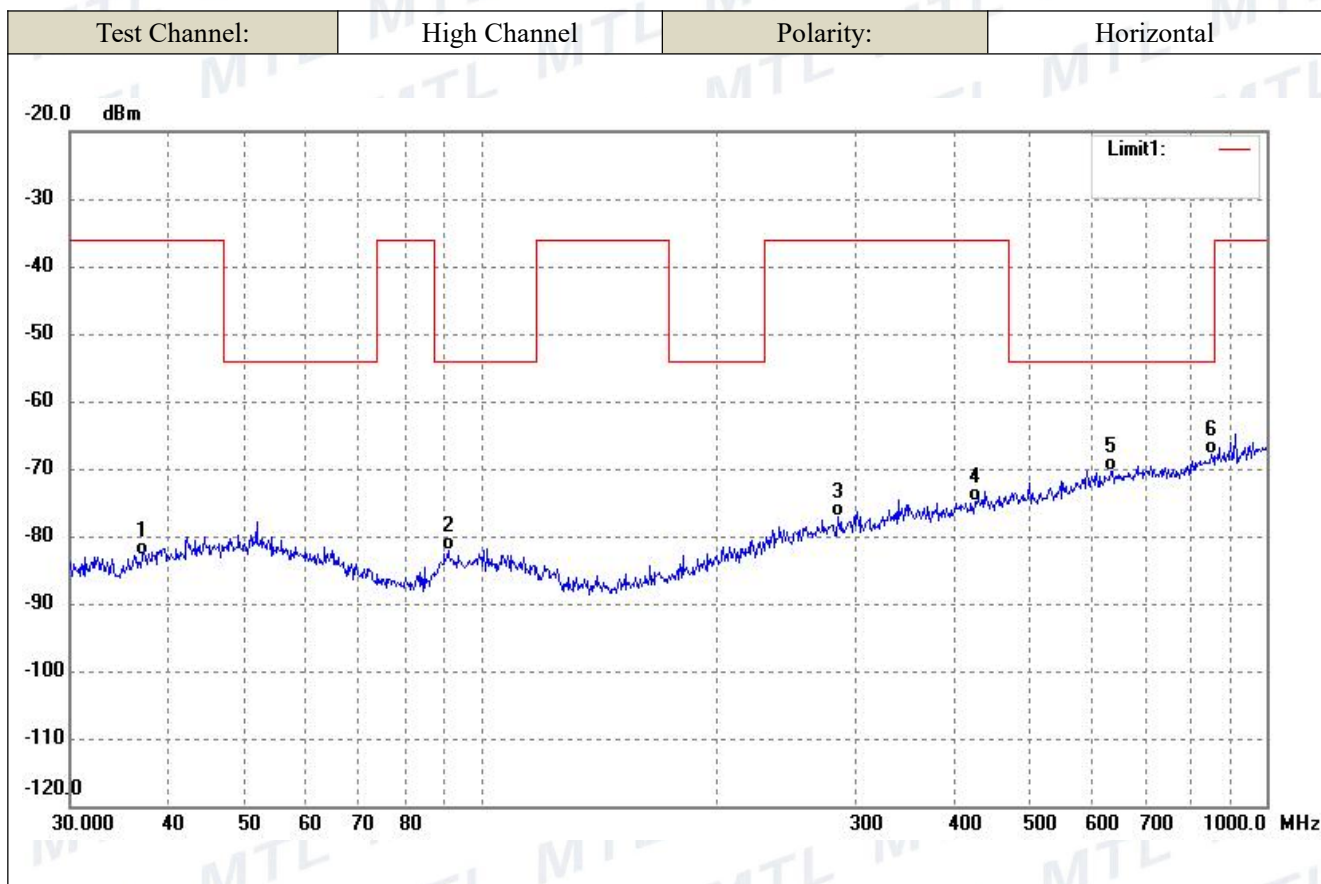

No.	Frequency (MHz)	Reading (dBm)	Correct Factor(dB)	Result (dBm)	Limit (dBm)	Margin (dB)	Remark
1	37.0249	-80.93	-1.84	-82.77	-36.00	-46.77	ERP
2	90.8554	-80.39	-1.77	-82.16	-54.00	-28.16	ERP
3	284.9767	-80.10	2.97	-77.13	-36.00	-41.13	ERP
4	425.0280	-80.57	5.61	-74.96	-36.00	-38.96	ERP
5	633.9073	-79.45	9.09	-70.36	-54.00	-16.36	ERP
6	851.0353	-79.59	11.60	-67.99	-54.00	-13.99	ERP

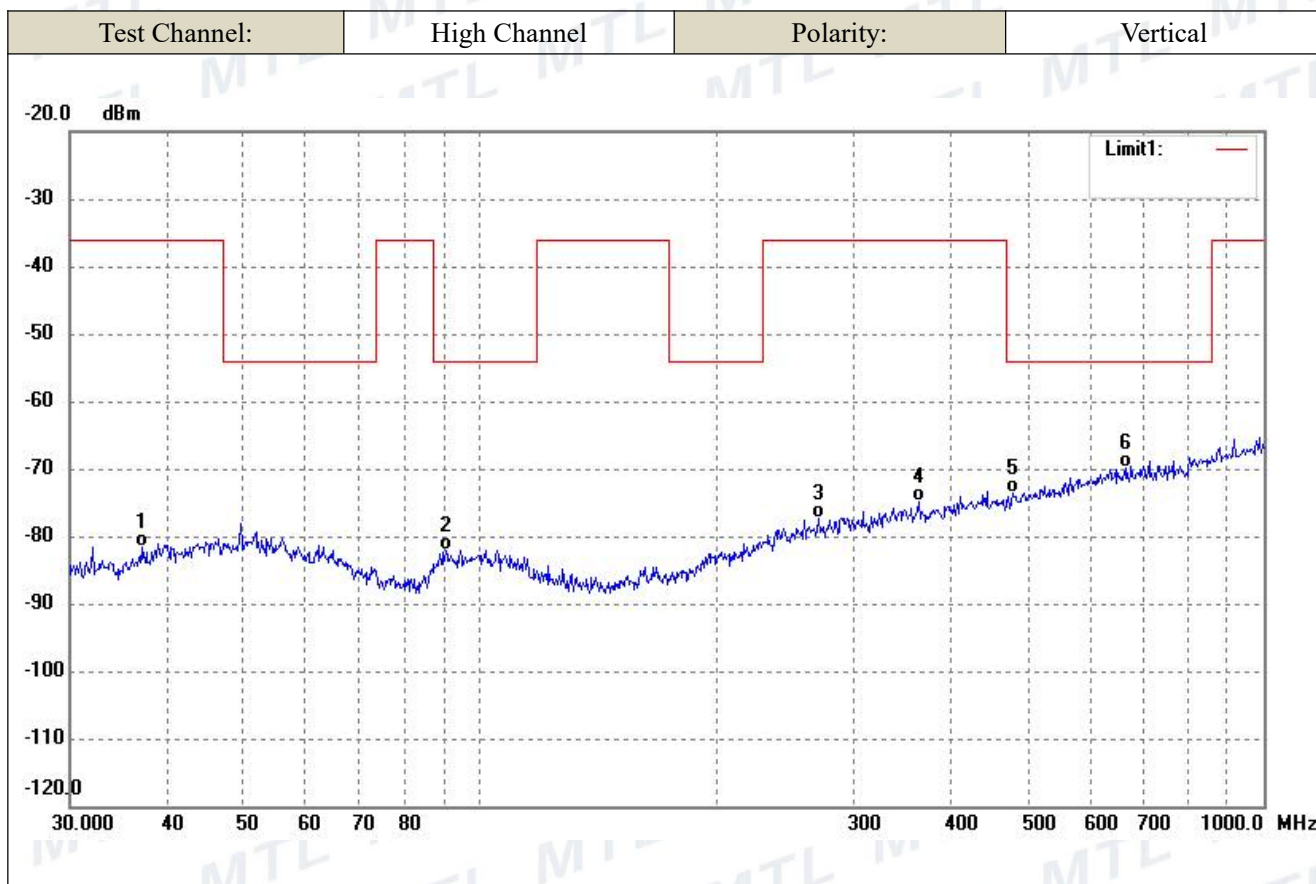

No.	Frequency (MHz)	Reading (dBm)	Correct Factor(dB)	Result (dBm)	Limit (dBm)	Margin (dB)	Remark
1	37.0249	-79.80	-1.84	-81.64	-36.00	-45.64	ERP
2	90.5374	-80.49	-1.71	-82.20	-54.00	-28.20	ERP
3	270.3748	-79.99	2.71	-77.28	-36.00	-41.28	ERP
4	362.9845	-79.43	4.57	-74.86	-36.00	-38.86	ERP
5	478.8456	-79.61	5.97	-73.64	-54.00	-19.64	ERP
6	668.1423	-79.16	9.22	-69.94	-54.00	-15.94	ERP



➤ Spurious Emission Above 1GHz
For EDR

Frequency (MHz)	Reading (dBm)	Correct dB	Result (dBm)	Limit (dBm)	Margin (dB)	Polar H/V
Low Channel-2402MHz						
4804.00	-51.44	7.92	-43.52	-30.00	-13.52	H
7206.00	-55.38	13.64	-41.74	-30.00	-11.74	H
4804.00	-50.75	7.92	-42.83	-30.00	-12.83	V
7206.00	-56.06	13.97	-42.09	-30.00	-12.09	V
High Channel-2480MHz						
4960.00	-50.69	8.27	-42.42	-30.00	-12.42	H
7440.00	-55.36	13.73	-41.63	-30.00	-11.63	H
4960.00	-51.01	8.27	-42.74	-30.00	-12.74	V
7440.00	-55.58	13.73	-41.85	-30.00	-11.85	V

Note 1: Testing is carried out with frequency rang 30MHz to 12.75GHz, which above 4th Harmonics are attenuated more than 20dB below the permissible limits or the field strength is too small to be measured.

Note 2: this EUT was tested in 3 orthogonal positions and the worst case position data was reported.



➤ **Conducted Transmitter Spurious Emission:**

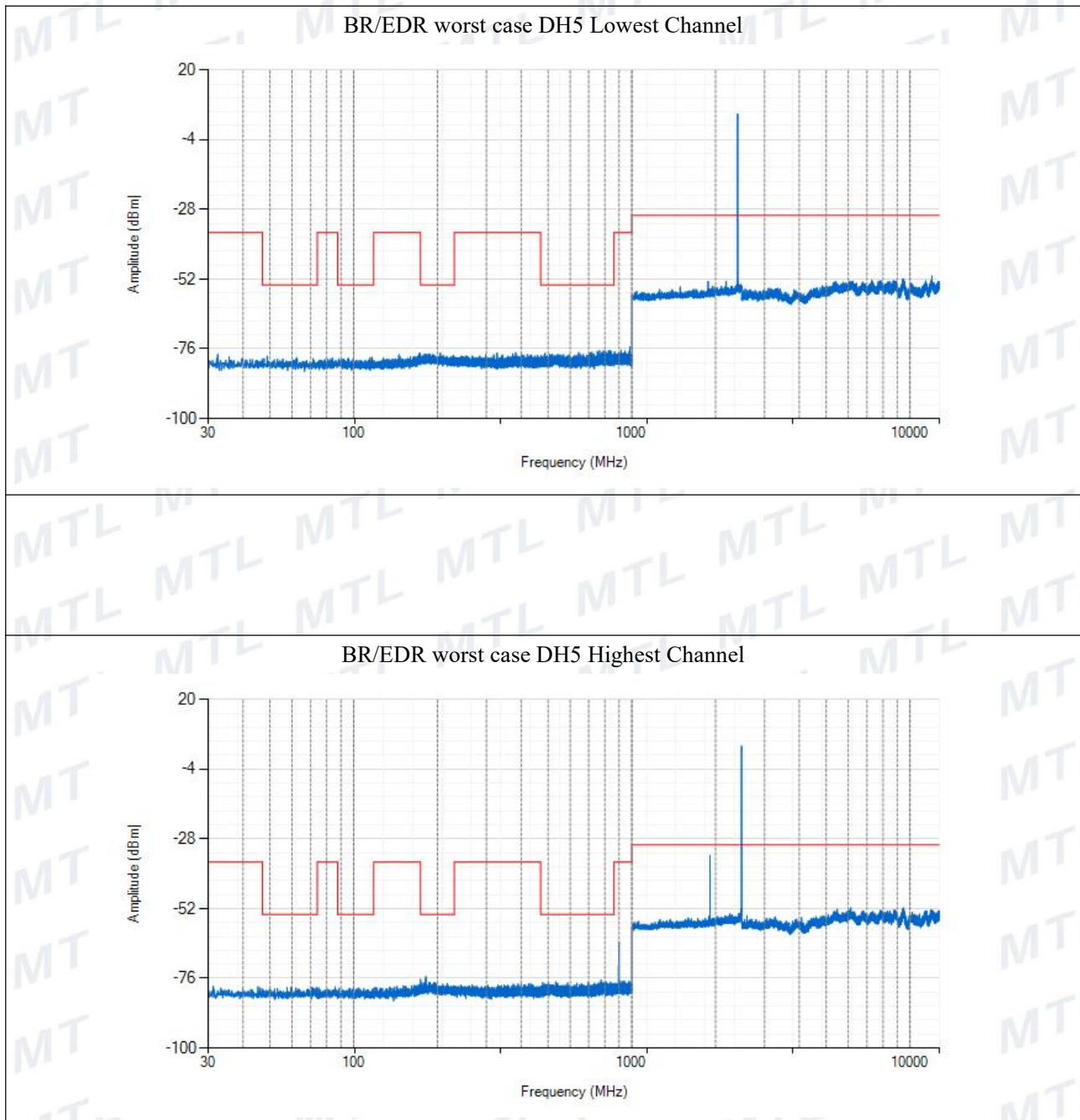

Note 1: Testing is carried out with frequency rang 30MHz to 12.75GHz, which emissions are too small are not list above. Test The worst case is DH5.



9. Receiver Spurious Emissions

9.1 Standard Applicable

According to section 4.3.1.11.3&4.3.2.10.3, the spurious emissions of the receiver shall not exceed the values given in table below

NOTE: In case of equipment with antenna connectors, these limits apply to emissions at the antenna port (conducted) and to the emissions radiated by the cabinet. In case of integral antenna equipment (without temporary antenna connectors), these limits apply to emissions radiated by the equipment. Spurious emission limits for receivers

Frequency range	Maximum power	Bandwidth
30 MHz to 1 GHz	-57 dBm	100 kHz
1 GHz to 12,75 GHz	-47 dBm	1 MHz

9.2 Test Procedure

The device under test has an integral antenna and the radiated measurement shall apply to the device, using the method of measurement as described in the EN300328 section 5.4.10.2.

RBW=100kHz VBW=300kHz 30MHz-1GHz
RBW=1MHz VBW=3MHz 1GHz-12.75GHz

9.3 Summary of Test Results/Plots

According to the data, the EUT complied with the EN 300328 standards, and had the worst case:



➤ Receiver Spurious Emission From 30MHz To 1GHz

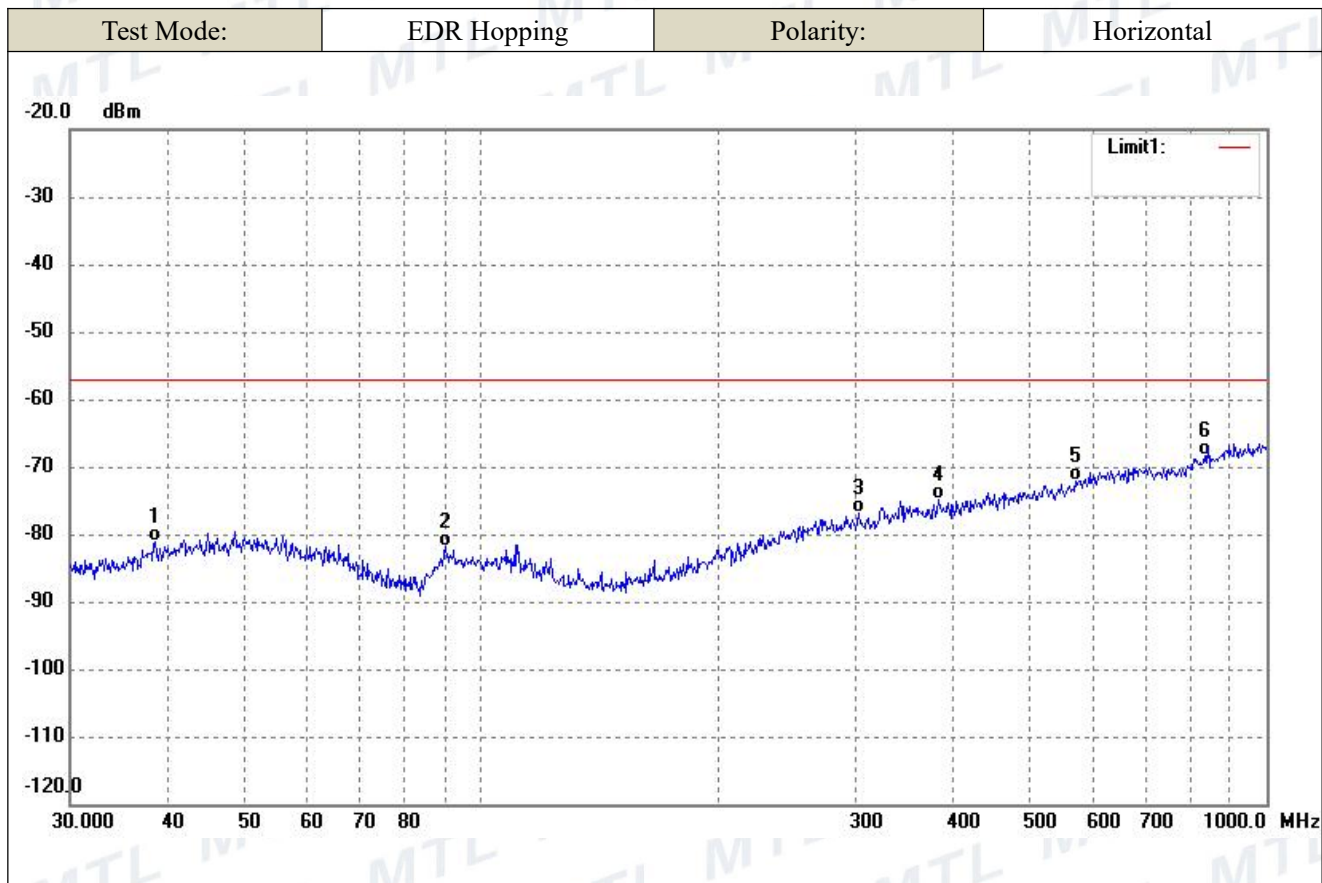

No.	Frequency (MHz)	Reading (dBm)	Correct Factor(dB)	Result (dBm)	Limit (dBm)	Margin (dB)	Remark
1	38.4809	-79.79	-1.29	-81.08	-57.00	-24.08	ERP
2	90.2205	-80.21	-1.77	-81.98	-57.00	-24.98	ERP
3	302.4812	-79.91	3.03	-76.88	-57.00	-19.88	ERP
4	382.5879	-79.02	4.08	-74.94	-57.00	-17.94	ERP
5	570.6100	-78.12	5.88	-72.24	-57.00	-15.24	ERP
6	833.3171	-75.15	6.76	-68.39	-57.00	-11.39	ERP

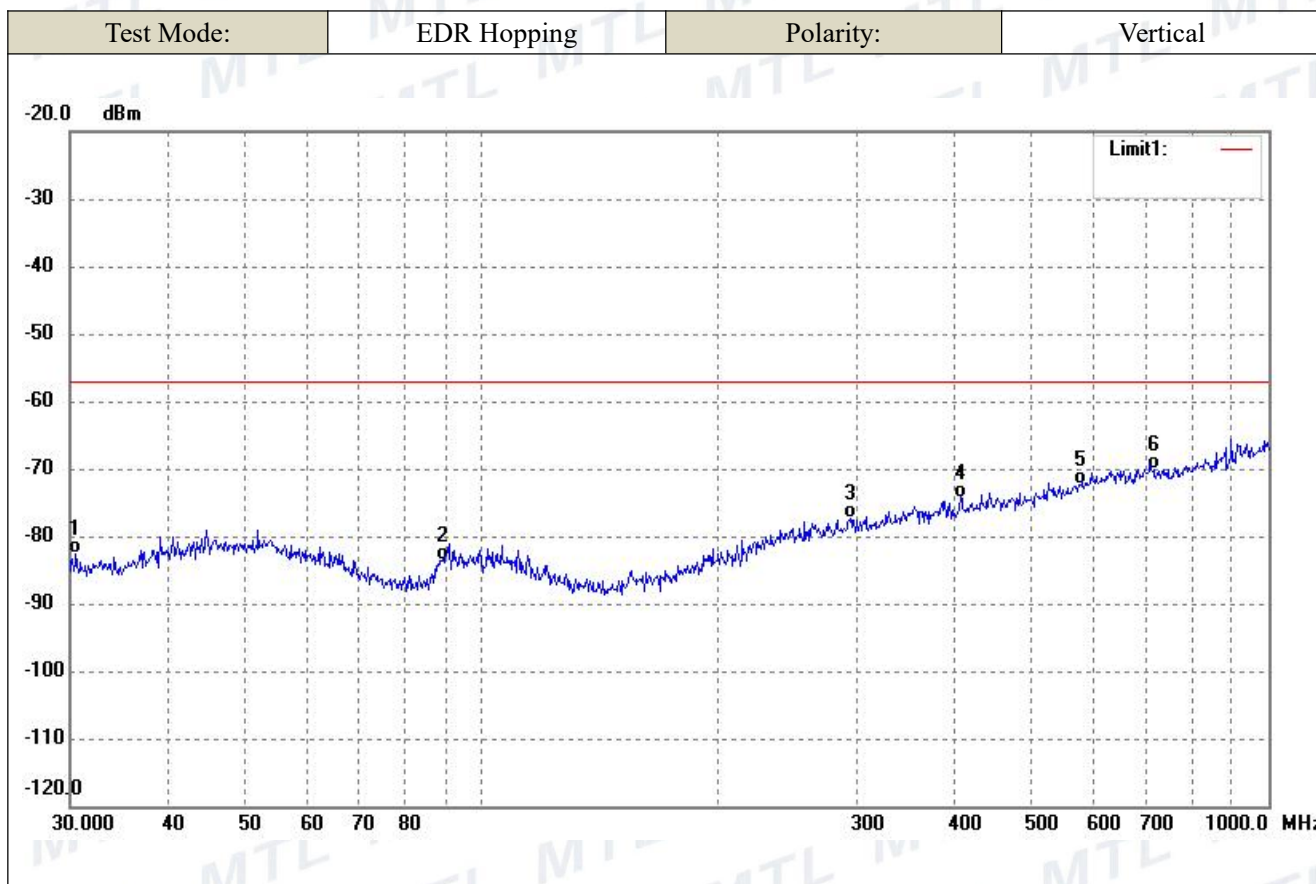

No.	Frequency (MHz)	Reading (dBm)	Correct Factor(dB)	Result (dBm)	Limit (dBm)	Margin (dB)	Remark
1	30.5306	-79.71	-2.90	-82.61	-57.00	-25.61	ERP
2	88.9639	-81.02	-2.54	-83.56	-57.00	-26.56	ERP
3	294.1137	-80.42	3.01	-77.41	-57.00	-20.41	ERP
4	406.0880	-78.65	4.40	-74.25	-57.00	-17.25	ERP
5	574.6258	-78.36	6.05	-72.31	-57.00	-15.31	ERP
6	714.1734	-76.45	6.43	-70.02	-57.00	-13.02	ERP



➤ Receiver Spurious Emission Above 1GHz
Hopping Mode

Frequency (MHz)	Result (dBm)	Limit (dBm)	Margin (dB)	Polar H/V
1515.00	-62.32	-47.00	-15.32	H
3263.00	-63.74	-47.00	-16.74	H
4072.00	-62.09	-47.00	-15.09	V
5605.00	-62.27	-47.00	-15.27	V

Note: Testing is carried out with frequency rang 30MHz to 12.75GHz, which above 1GHz are attenuated more than 20dB below the permissible limits or the field strength is too small to be measured.



Conducted Receiver Spurious Emission:

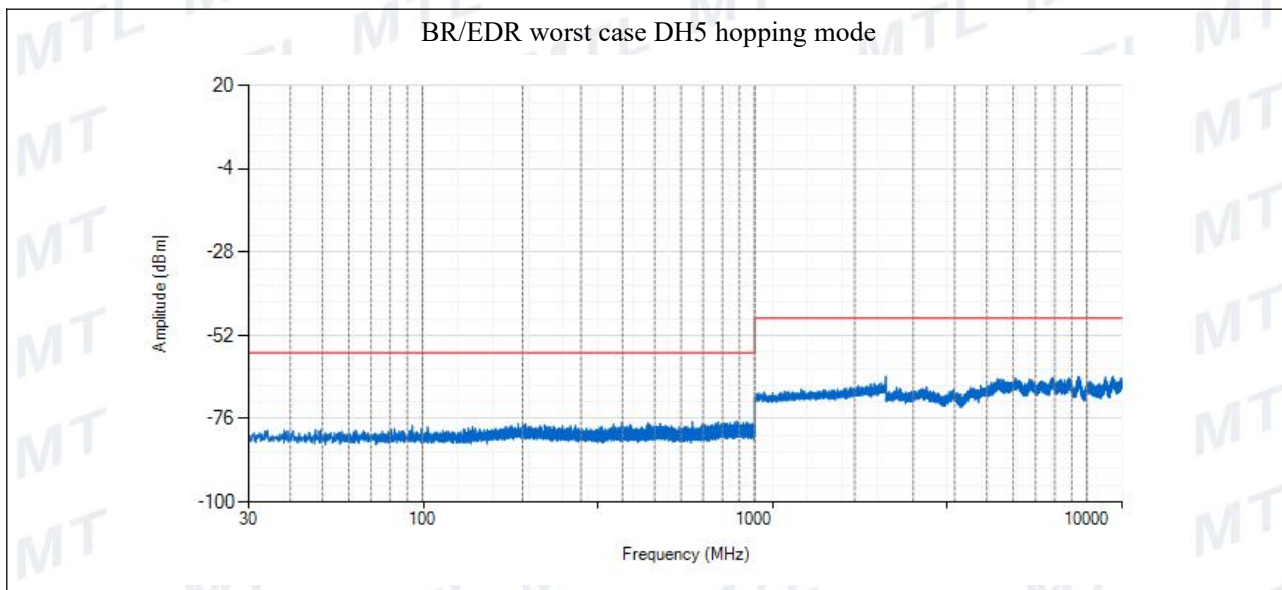

Note 1: Testing is carried out with frequency rang 30MHz to 12.75GHz, which emissions are too small are not list above.



10. Receiver Blocking

10.1 Standard Application

According to section 4.3.2.11.2, receiver blocking is a measure of the ability of the equipment to receive a wanted signal on its operating channel without exceeding a given degradation in the presence of an unwanted signal (blocking signal) at frequencies other than those of the operating band.

Load Based Equipment not using any of the mechanisms referenced above shall comply with the following minimum set of requirements :

The minimum performance criterion shall be a PER less than or equal to 10 %. The manufacturer may declare alternative performance criteria as long as that is appropriate for the intended use of the equipment (see clause 5.4.1.t)).

While maintaining the minimum performance criteria as defined in clause 4.3.2.11.3, the blocking levels at specified frequency offsets shall be equal to or greater than the limits defined for the applicable receiver category 1, 2 and 3 provided in table 14, table 15 or table 16.

Receiver category 1

Adaptive equipment with a maximum RF output power greater than 10 dBm e.i.r.p. shall be considered as receiver category 1 equipment.

Receiver category 2

Non-adaptive equipment with a Medium Utilization (MU) factor greater than 1 % and less than or equal to 10 % or adaptive equipment with a maximum RF output power of 10 dBm e.i.r.p. shall be considered as receiver category 2 equipment.

Receiver category 3

Non-adaptive equipment with a maximum Medium Utilization (MU) factor of 1 % or adaptive equipment with a maximum RF output power of 0 dBm e.i.r.p. shall be considered as receiver category 3 equipment.



Table 14: Receiver Blocking parameters for Receiver Category 1 equipment

Wanted signal mean power from companion device (dBm)	Blocking signal frequency (MHz)	Blocking signal power (dBm) (see note 2)	Type of blocking signal
$P_{min} + 6 \text{ dB}$	2 380	-53	CW
	2 503,5	-53	CW
$P_{min} + 6 \text{ dB}$	2 300	-47	CW
	2 330		
	2 360		
$P_{min} + 6 \text{ dB}$	2 523,5	-47	CW
	2 553,5		
	2 583,5		
	2 613,5		
	2 643,5		
	2 673,5		

NOTE 1: P_{min} is the minimum level of the wanted signal (in dBm) required to meet the minimum performance criteria as defined in clause 4.3.2.11.3 in the absence of any blocking signal.

NOTE 2: The levels specified are levels in front of the UUT antenna. In case of conducted measurements, the levels have to be corrected by the actual antenna assembly gain.

Table 15: Receiver Blocking parameters receiver category 2 equipment

Wanted signal mean power from companion device (dBm)	Blocking signal frequency (MHz)	Blocking signal power (dBm) (see note 2)	Type of blocking signal
$P_{min} + 6 \text{ dB}$	2 380	-57	CW
	2 503,5		CW
$P_{min} + 6 \text{ dB}$	2 300	-47	CW
	2 583,5		CW

NOTE 1: P_{min} is the minimum level of the wanted signal (in dBm) required to meet the minimum performance criteria as defined in clause 4.3.2.11.3 in the absence of any blocking signal.

NOTE 2: The levels specified are levels in front of the UUT antenna. In case of conducted measurements, the levels have to be corrected by the actual antenna assembly gain.



Table 16: Receiver Blocking parameters receiver category 3 equipment

Wanted signal mean power from companion device (dBm)	Blocking signal frequency (MHz)	Blocking signal power (dBm) (see note 2)	Type of blocking signal
P _{min} + 12 dB	2 380	-57	CW
	2 503,5		CW
P _{min} + 12 dB	2 300	-47	CW
	2 583,5		CW

NOTE 1: P_{min} is the minimum level of the wanted signal (in dBm) required to meet the minimum performance criteria as defined in clause 4.3.2.11.3 in the absence of any blocking signal.

NOTE 2: The levels specified are levels in front of the UUT antenna. In case of conducted measurements, the levels have to be corrected by the actual antenna assembly gain.

10.2 Test Procedure

- Step 1: • For non-frequency hopping equipment, the UUT shall be set to the lowest operating channel.
- Step 2: • The blocking signal generator is set to the first frequency as defined in the appropriate table corresponding to the receiver category and type of equipment.
- Step 3: • With the blocking signal generator switched off, a communication link is established between the UUT and the associated companion device using the test setup shown in figure 6. The variable attenuator is set to a value that achieves the minimum performance criteria as specified in clause 4.3.1.12.3 or clause 4.3.2.11.3 with a resolution of at least 1 dB. The resulting level for the wanted signal at the input of the UUT is P_{min}. This value shall be measured and recorded in the test report.
 - The signal level is increased by the value provided in the table corresponding to the receiver category and type of equipment.
- Step 4: • The blocking signal at the UUT is set to the level provided in the table corresponding to the receiver category and type of equipment. It shall be verified and recorded in the test report that the performance criteria as specified in clause 4.3.1.12.3 or clause 4.3.2.11.3 is met.
- Step 5: • Repeat step 4 for each remaining combination of frequency and level for the blocking signal as provided in the table corresponding to the receiver category and type of equipment.
- Step 6: • For non-frequency hopping equipment, repeat step 2 to step 5 with the UUT operating at the highest operating channel.

10.3 Test Setup

According to the section 5.4.11.2.1, the test block diagram shall be used.

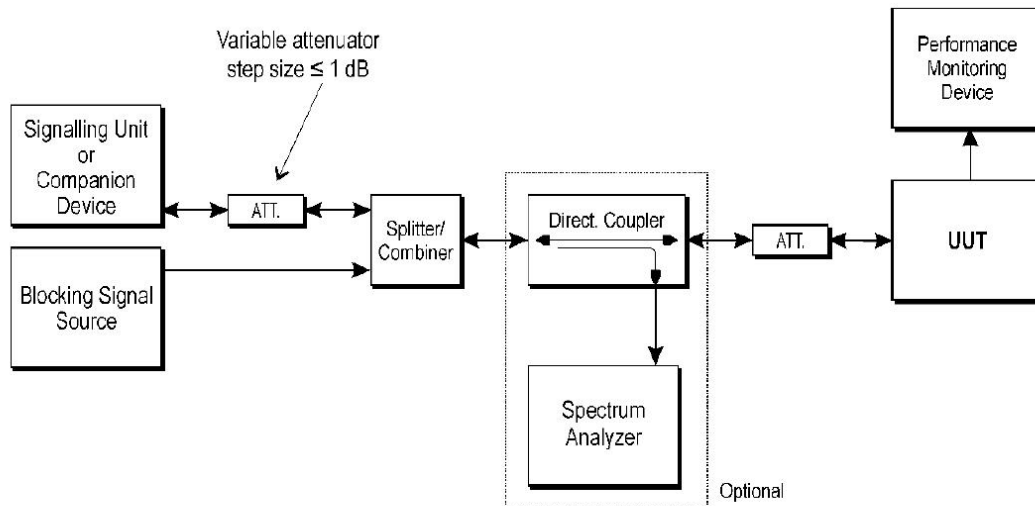

Figure 6: Test Set-up for receiver blocking

All test procedure is carried to the section 5.4.11.2.1
RBW/VBW=8MHz/30MHz



10.4 Summary of Test Results/Plots

The product is receiver category 2

Hopping Mode GFSK	
Minimum Performance Criteria (@BER=0.01%) (dBm)	-88.41
Pmin+6dB(dBm)	-82.41
①Blocking Signal Frequency(MHz)	2380, 2503.5
①Block Signal Level (dBm)	-57.00
②Blocking Signal Frequency(MHz)	2300, 2583.5
②Block Signal Level (dBm)	-47.00
Test Result(BER):	0.001%(<0.01%)
Hopping Mode Pi/4 DQPSK	
Minimum Performance Criteria (@BER=0.01%) (dBm)	-86.75
Pmin+6dB(dBm)	-80.75
①Blocking Signal Frequency(MHz)	2380, 2503.5
①Block Signal Level (dBm)	-57.00
②Blocking Signal Frequency(MHz)	2300, 2583.5
②Block Signal Level (dBm)	-47.00
Test Result(BER):	0.001%(<0.01%)
Hopping Mode 8DPSK	
Minimum Performance Criteria (@BER=0.01%) (dBm)	-88.48
Pmin+6dB(dBm)	-82.48
①Blocking Signal Frequency(MHz)	2380, 2503.5
①Block Signal Level (dBm)	-57.00
②Blocking Signal Frequency(MHz)	2300, 2583.5
②Block Signal Level (dBm)	-47.00
Test Result(BER):	0.001%(<0.01%)

*communication link is established between the UUT and the associated companion device using the test setup shown in figure 6. While the Companion device (CMW500) adjust to a level which can obtain the minimum performance criteria BER 0.01%(this is defined by manufacturer),This level define to Pmin

Remark: the smallest channel bandwidth shall be used together with the lowest data rate for this channel bandwidth. This mode of operation are aligned with the performance criteria defined in clause 4.3.1.12.3 or clause 4.3.2.11.3 as declared by the manufacturer (see clause 5.4.1.t)).

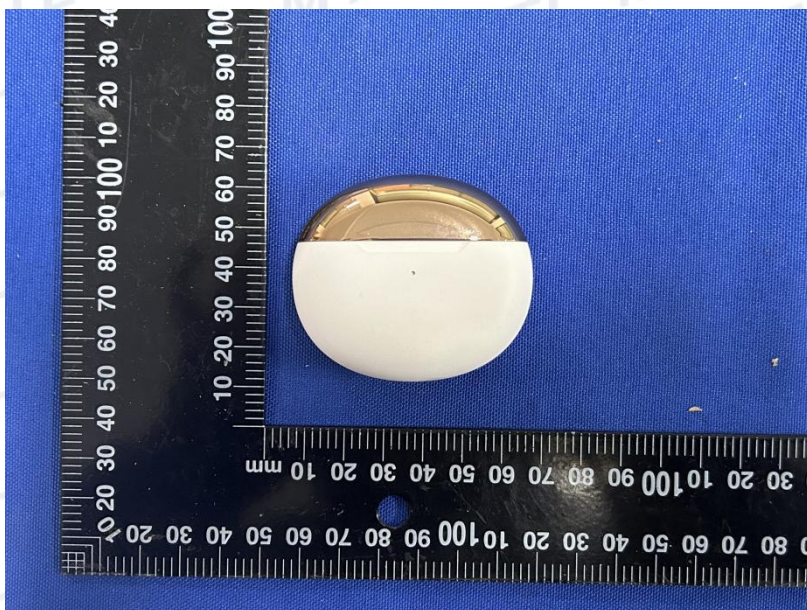

FIGURE 1

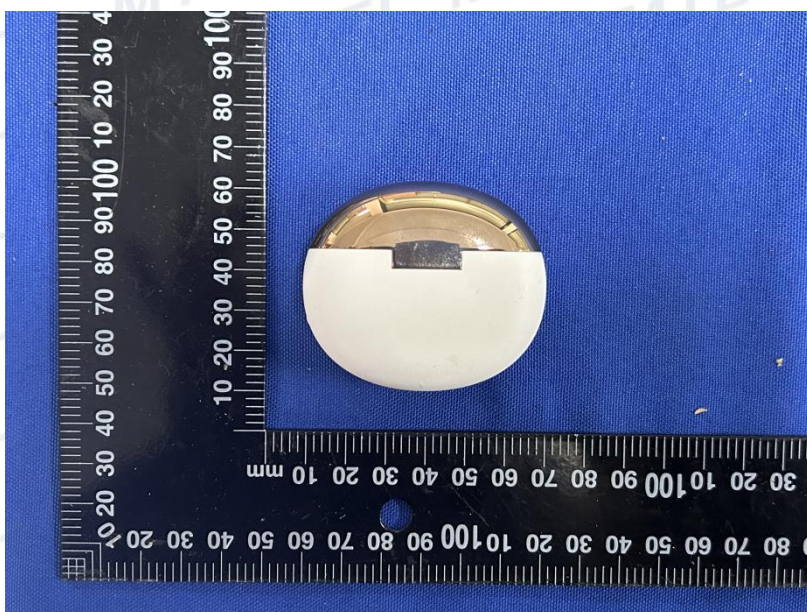

FIGURE 2

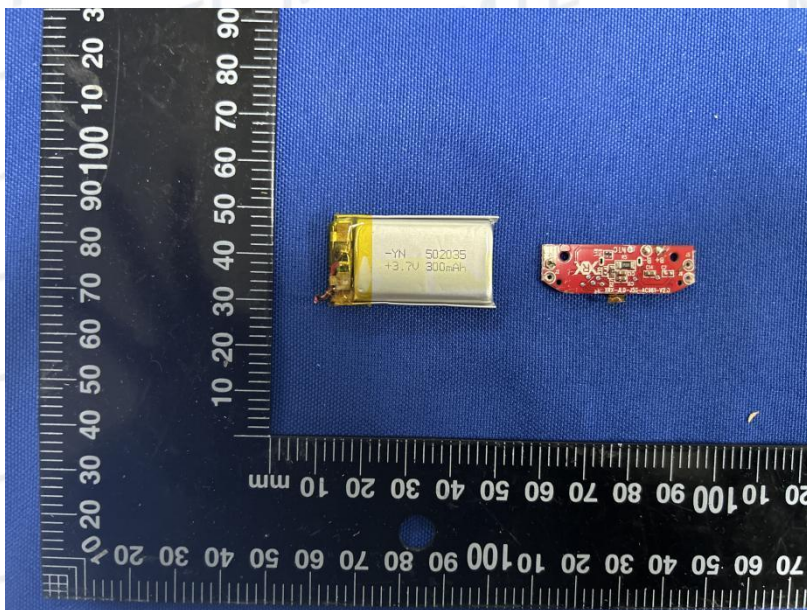

FIGURE 3

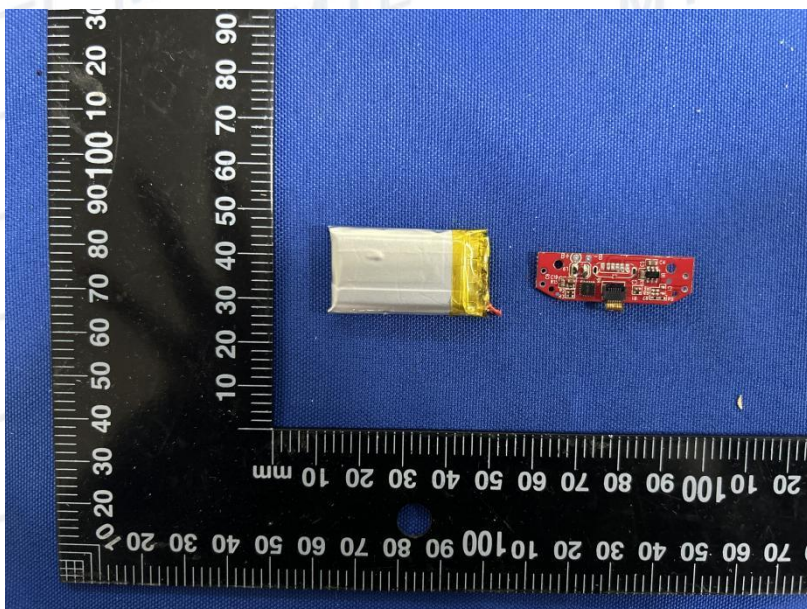

FIGURE 4

End of Report